



Landscape Product Guide

MIDWEST USA | EDITION 2.0





Contents

Introduction

- 02 Our Commitment
- 03 The 5 Axes of Design
- 04 Project Gallery

Slabs & Pavers

- 12 Classic Paver
- 13 Colonnade
- 14 Market Paver 60mm **NEW!**
- 15 Molina® 60mm
- 16 Nueva® Slab
- 17 Nueva® XL Slab
- 18 Rialto 60mm
- 19 Strassa **NEW!**
- 20 Ridgefield Plus
- 21 Ridgefield Smooth
- 22 Enviro Midori
- 23 Market Paver 80mm
- 24 Molina® 80mm
- 25 Nueva® Paver
- 26 Rialto 80mm
- 27 Villanova
- 28 Eterna

Copings, Curbs & Steps

- 30 Oasis
- 31 Cassina
- 32 Fronterra Curb
- 33 Nueva® Curb
- 34 Aria Step
- 35 Nueva® Step

Walls

- 38 Gardenia Linear
- 39 Laredo
- 39 Laredo Smooth
- 40 Modan
- 41 Modeco One
- 42 Nueva® 75 Wall
- 43 Nueva® 150 Wall
- 44 Ortana
- 45 Proterra™ Smooth
- 46 Proterra™ Split

Planning & Specifications

- 48 Laying Patterns
- 49 ONESand
- 50 Recommended Uses
- 52 Packaging Specifications
- 55 Choosing a Contractor
- 56 Wall Capabilities Chart



Made in Canada

Some products or sizes are made in Canada, and may not be stocked in the USA. Please contact your local authorized Oaks distributor or Territory Manager for additional information.



Pedestrian Traffic

Suitable for pedestrian use only, such as walkways and patios.



Vehicular Traffic

Suitable for residential vehicle use such as driveways, as well as walkways and patios.



Solar Reflectance Index

High solar reflectance keeps pavement area cooler. A higher number indicates greater reflectance.



Permeable

Designed to allow increased drainage between paver joints and into the ground.



EliteFinish™

Product produced with enhanced finish technology.



ColorBold™

Product produced with enhanced color technology.

Legend



Stay up-to-date!

Visit our **interactive online product guide** for additional photo and video content and post-publication updates.

Scan to view!

MANUFACTURING EXCELLENCE & QUALITY

Our commitment.

Through thick and thin, our company is constantly evolving. We've expanded our manufacturing many times over the years, most recently at our Brampton concrete products plant. This expansion gives us the capacity to produce both masonry and landscape products, as an integrated masonry and landscape products manufacturer and a single source for quality, durability and long-lasting style.

Your trust keeps us focused on our goal, and motivates us to strive to do more, to do better, to evolve along with the needs of our clients and industry trends. From our state-of-the-art production facilities to quality control, distribution and customer service, we ensure our products are made to last.

Thank you for making us your **ONE Trusted Source**.



150⁺

Years of manufacturing
landscape & masonry
products

400⁺

Dedicated employees
working to serve you

8

Manufacturing
facilities across
North America

295⁺

Dealers across
North America

All of our well-integrated product collections are built around different sets of design characteristics, yet revolve around five common axes.

Simplicity

Our product design process begins with simplicity; A well-conceived lack of complexity that makes our masonry and landscape collections easier to design, quote, and install your most beautiful project vision every time.

Artistry

Our fifth axis of design is about you. The preceding four axes provide all the ingredients for enhancing your creativity in any project: versatility in product size, shape, scale, and color for an optimum product offering. The true artistry is in selecting and utilizing products from our various collections to express your creativity.

Modularity

The sizes and scale of our products were developed for mixing and matching different products within each collection for a completely coordinated look. Each individually distinct unit in our product lines aids in building a continuous function.

THE 5 AXES OF Design

Unity

Our masonry and landscape products are designed for use together in unison. The continuity, affinity of colors, textures, surface finishes, product sizes and scale within our product collections allow various options for combining all these parts into a unified vision where all the elements of your outdoor design fit together.

Continuity

Every successful home plan pivots around continuity. The unity between form and function, front and back yards, between horizontal and vertical surfaces, and even from masonry to landscape is what truly pulls an outdoor design theme together.



Learn more about our Collections!
Visit www.bramptonbrick.com/en/our-collections



Slabs: Molina® 60mm, Moraine
Walls & Firepit: Nueva® 75, Champagne
with Onyx coping

Entertaining around the fire or pool have never looked better! Creating a luxurious or cozy backyard retreat is made simple with our collection of paver, slab and wall products.





LEFT:
Wall, Pillars & Firepit: Ortana, Timberwood
Wall Caps: Ortana, Desert
Slabs: Molina® 60mm, Moraine with Twilight border

BOTTOM:
Slabs: Nueva® Slab, Champagne with Onyx border
Pool Coping: Nueva® Coping, Champagne
Walls & Steps: Proterra™ Smooth, Natural





Slabs: Nueva® Slab, Champagne with Onyx border
Pool Coping: Nueva® Coping, Onyx
Wall: Proterra™ Smooth, Natural
Firepit: Modan, Marble Grey with Twilight accent

Carry your design aesthetic from curbside to poolside! Our paver, slab and wall products work in unison to deliver style, durability and a lifetime of worry-free enjoyment.

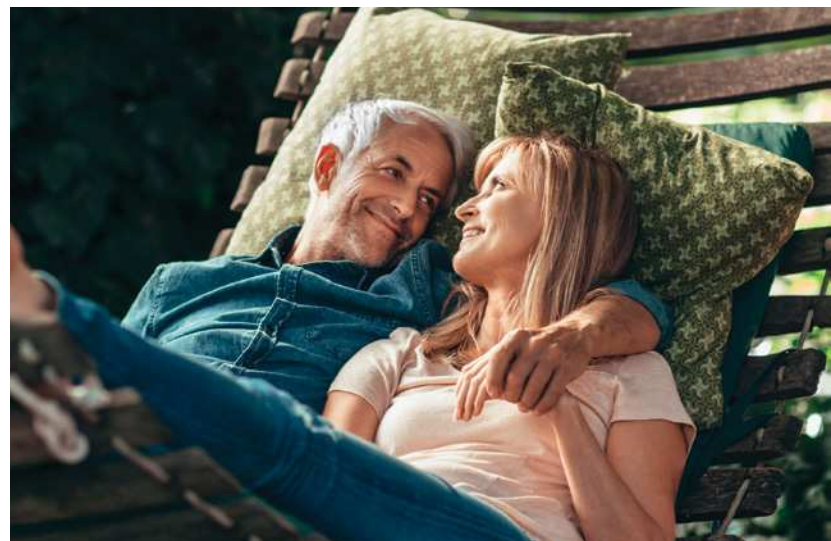



TOP:
Water Feature: Modan,
Marble Grey with Twilight accent



LEFT:
Pavers: Nueva® Paver, Champagne
with Onyx border



Pavers: Rialto 80mm, Mackinaw



LEFT:
Pavers: Rialto 80mm,
Champagne with Onyx border
(sealed with gloss sealant)

BOTTOM:
Slabs: Nueva® Slab,
Marble Grey with Onyx border
Walls & Firepit: Nueva® 150,
Marble Grey with Marble Grey coping





A photograph of a stone wall with windows and a garden bed with plants and a paved walkway. The stone wall is made of large, irregular stones in shades of grey and brown. There are two windows with dark frames. In front of the wall is a garden bed with mulch, several green plants, and a small bush with red flowers. A paved walkway made of large, rectangular pavers in shades of grey and brown runs along the edge of the garden bed.

Pavers: Nueva® Paver, Champagne
with Onyx border

Slabs & Pavers

Traditional or modern, smooth or textured, tumbled or straight-edge? The choice is yours! We have styles to suit any aesthetic, color palettes that compliment any preference, and products that work together to tie all your project elements together, perfectly.

Classic Paver 60mm



Nueva® Collection



CHAMPAGNE



MARBLE GREY



CHESTNUT



ONYX



4x4 Stone
3.94 x 3.94"
(100 x 100mm)



4x8 Stone
3.94 x 7.87"
(100 x 200mm)

2 STONE STANDARD BUNDLE

Colonnade 60mm



Legacy Collection



Pavers: Colonnade, Silversand



GREYFIELD



ONYX

Onyx available in 6x9 Stone only. Ideal for soldier coursing or banding.



SANDALWOOD



SILVERSAND



TIMBERWOOD



3x6 Stone
2.95 x 5.91"
(75 x 150mm)



6x6 Stone
5.91 x 5.91"
(150 x 150mm)



6x9 Stone
5.91 x 8.86"
(150 x 225mm)
Individually Packaged



9x9 Stone
8.86 x 8.86"
(225 x 225mm)
Individually Packaged



9x12 Stone
8.86 x 11.81"
(225 x 300mm)
Individually Packaged

2 STONE COMBO BUNDLE

Market Paver 60mm



Eterna Collection

NEW PRODUCT!



MARBLE GREY



ONYX



SANGRIA



SERENGETI

Pavers: Market Paver 60mm, Sangria with Onyx border and Strassa, Marble Grey inset

Curb: Nueva® Curb, Marble Grey

Wall: Nueva® 150, Marble Grey with Cloudburst coping



4x8 Stone
3.94 x 7.87"
(100 x 200mm)

Molina® 60mm



Eterna Collection



CLOUDBURST



MORAINE



LUNA



TWILIGHT



TWILIGHT, FERRO FINISH **NEW!**

Twilight, Ferro Finish: Slip-resistant finish, ideal for soldier coursing, banding and accents.

Stocked in 6x12 Stone size only.



Learn more about Ferro Finish 60mm. **Scan here.**

Slabs: Molina® 60mm, Moraine
Walls & Steps: Nueva® 75, Champagne with Onyx caps & treads



12x12 Stone
 11.81 x 11.81"
 (300 x 300mm)



12x18 Stone
 11.81 x 17.72"
 (300 x 450mm)



12x24 Stone
 11.81 x 23.62"
 (300 x 600mm)



6x12 Stone
 5.91 x 11.81"
 (150 x 300mm)
Individually Packaged



12x24 Stone
 11.81 x 23.62"
 (300 x 600mm)
Individually Packaged



24x24 Stone
 23.62 x 23.62"
 (600 x 600mm)
Individually Packaged

3 STONE COMBO BUNDLE

Nueva® Slab 60mm



Nueva® Collection



CHAMPAGNE



CHESTNUT



CLOUDBURST



ONYX



MARBLE GREY

Chestnut available in 8x16 Small Rectangle size only. Ideal for soldier coursing or banding.



MILANO

Slabs: Nueva® Slab, Champagne with Onyx border
Steps, Walls & Firepit: Nueva® 150, Champagne with Champagne coping
Pillars: Modan, Champagne



8x16 Small Rectangle
 7.87 x 15.75"
 (200 x 400mm)



16x16 Stone
 15.75 x 15.75"
 (400 x 400mm)



16x24 Stone
 15.75 x 23.62"
 (400 x 600mm)



8x16 Small Rectangle
 7.87 x 15.75"
 (200 x 400mm)

Individually Packaged
 Available in Chestnut
 and Onyx only



12x24 Rectangle 
 11.81 x 23.62"
 (300 x 600mm)
Individually Packaged

NOTE: When using the 12x24 Rectangle with other sizes within the Nueva® product line, please understand that colors and tonal consistency may not be exact matches.

3 STONE RANDOM BUNDLE

Nueva® XL Slab 60mm



Nueva® Collection



Slabs: Nueva® XL Slab, Marble Grey
Step Tread: Nueva® Coping, Marble Grey
Firepit: Nueva® 150, Marble Grey



24x36 Stone
 23.62 x 35.43"
 (600 x 900mm)
Individually Packaged



CHAMPAGNE



ONYX



CLOUDBURST



MARBLE GREY



MILANO

NOTE: When using Nueva® Slab with Nueva® XL, please understand that colors and tonal consistency between these products may not be exact matches.

Rialto 60mm



Rialto Collection



Slabs: Rialto 60mm, Marble Grey with Onyx border



CHAMPAGNE



CHESTNUT



MACKINAW



ONYX



MARBLE GREY

Chestnut and Onyx are available in 8x16 Stone size only. Ideal for soldier coursing or banding.



MILANO



8x16 Stone
7.87 x 15.75"
(200 x 400mm)



16x16 Stone
15.75 x 15.75"
(400 x 400mm)



16x24 Stone
15.75 x 23.62"
(400 x 600mm)



8x16 Stone
7.87 x 15.75"
(200 x 400mm)
Individually Packaged

Available in Chestnut and Onyx only



16x24 Stone
15.75 x 23.62"
(400 x 600mm)
Individually Packaged

3 STONE RANDOM BUNDLE

Strassa 60mm



Eterna Collection

NEW PRODUCT!

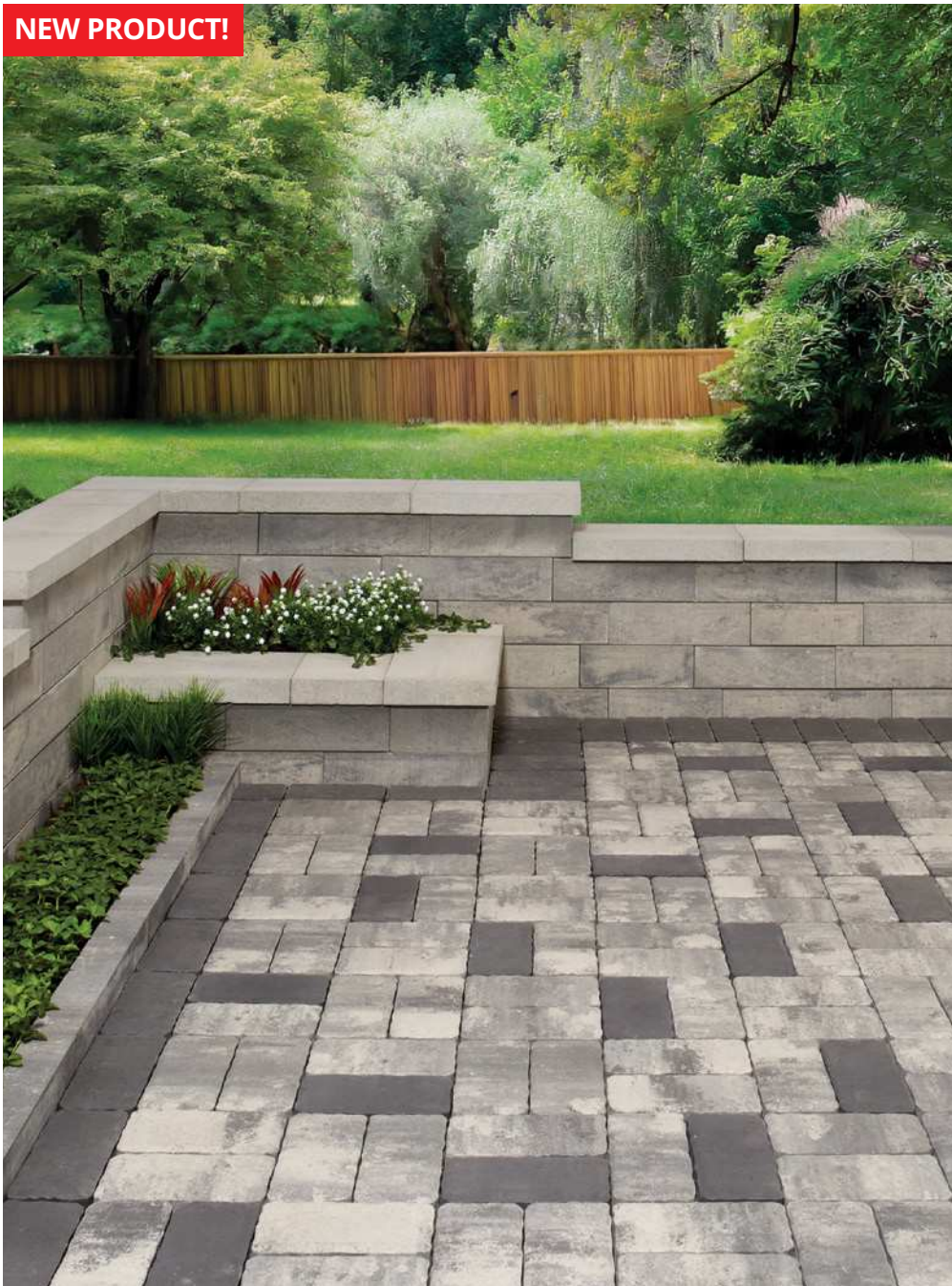

BISCUIT



COLLEGE RED



MARBLE GREY



TWILIGHT

Pavers: Strassa, Marble Grey with Twilight border and accent
Curb: Nueva® Curb, Marble Grey
Wall: Nueva® 150, Marble Grey with Cloudburst coping



6x12 Stone
5.91 x 11.81"
(150 x 300mm)
Individually Packaged

Ridgefield Plus 70mm



Rialto Collection



CHAMPAGNE



EXECUTIVE
Limited Availability



MARBLE GREY **NEW!**



ONYX

Onyx available in 8x12 Stone size only. Ideal for soldier coursing or banding.

Pavers: Ridgefield Plus, Champagne with Ridgefield Smooth, Onyx border and accent



8x12 Stone
7.87 x 11.81"
(200 x 300mm)



12x12 Stone
11.81 x 11.81"
(300 x 300mm)



12x16 Stone
11.81 x 15.75"
(300 x 400mm)



8x12 Stone
7.87 x 11.81"
(200 x 300mm)

Individually Packaged
Available in Onyx only

3 STONE LARGE COMBO BUNDLE

Ridgefield Smooth 70mm



Nueva® Collection



Pavers: Ridgefield Smooth, Champagne with Onyx border



CHAMPAGNE



CHESTNUT



MARBLE GREY



ONYX



MILANO

Chestnut and Onyx are available in 8x12 Stone size only. Ideal for soldier coursing or banding.



8x12 Stone
7.87 x 11.81"
(200 x 300mm)



12x12 Stone
11.81 x 11.81"
(300 x 300mm)



12x16 Stone
11.81 x 15.75"
(300 x 400mm)



8x12 Stone
7.87 x 11.81"
(200 x 300mm)

Individually Packaged

Available in Chestnut and Onyx only

3 STONE LARGE COMBO BUNDLE

Enviro Midori 80mm

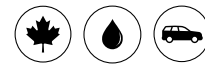

Nueva® Collection



CHAMPAGNE



MARBLE GREY



Learn about how
Permeable Pavers work.
[Scan here.](#)

Pavers: Enviro Midori, Champagne



5x10 Stone
4.72 x 9.45"
(120 x 240mm)



10x10 Stone
9.45 x 9.45"
(240 x 240mm)



10x15 Stone
9.45 x 14.17"
(240 x 360mm)

3 STONE RANDOM BUNDLE

Market Paver 80mm



Eterna Collection



MARBLE GREY **NEW!**



ONYX



SANGRIA



SERENGETI

Pavers: Market Paver 80mm, Sangria and Serengeti (blended onsite)



4x8 Stone
3.94 x 7.87"
(100 x 200mm)

Molina® 80mm



Eterna Collection



CLOUDBURST



MORAINE



LUNA



TWILIGHT



Twilight, Ferro Finish: Slip-resistant finish, ideal for soldier coursing, banding and accents.

Stocked in 6x12 Stone size only.

TWILIGHT, FERRO FINISH **NEW!**



Learn more about Ferro Finish 80mm. [Scan here.](#)

Pavers: Molina® 80mm, Moraine



12x12 Stone
11.81 x 11.81"
(300 x 300mm)



12x18 Stone
11.81 x 17.72"
(300 x 450mm)



12x24 Stone
11.81 x 23.62"
(300 x 600mm)



6x12 Stone
5.91 x 11.81"
(150 x 300mm)

Individually Packaged



12x24 Stone
11.81 x 23.62"
(300 x 600mm)

Individually Packaged

3 STONE COMBO BUNDLE

Nueva® Paver 80mm



Nueva® Collection



Pavers: Nueva® Paver, Champagne with Onyx border



CHAMPAGNE



ONYX



CLOUDBURST



UMBER



MARBLE GREY

Umber available in 8x16 Small Rectangle size only. Ideal for soldier coursing or banding.



MILANO



8x16 Small Rectangle
7.87 x 15.75"
(200 x 400mm)



16x16 Stone
15.75 x 15.75"
(400 x 400mm)



16x24 Stone
15.75 x 23.62"
(400 x 600mm)



8x16 Small Rectangle
7.87 x 15.75"
(200 x 400mm)
Individually Packaged
Available in ALL colors



16x32 Large Rectangle
15.75 x 31.50"
(400 x 800mm)
Individually Packaged

3 STONE RANDOM BUNDLE

NOTE: When using Nueva® Paver with 16x32 Large Rectangle, please understand that colors and tonal consistency between these products may not be exact matches.

Rialto 80mm



Rialto Collection



CHAMPAGNE



MACKINAW



MARBLE GREY



ONYX

Onyx available in 8x16 Stone size only. Ideal for soldier coursing or banding.

Pavers: Rialto 80mm, Champagne with Onyx border (sealed with gloss sealant)



8x16 Stone
7.87 x 15.75"
(200 x 400mm)



16x16 Stone
15.75 x 15.75"
(400 x 400mm)



16x24 Stone
15.75 x 23.62"
(400 x 600mm)



8x16 Stone
7.87 x 15.75"
(200 x 400mm)

Individually Packaged

Available in ALL colors



16x24 Stone
15.75 x 23.62"
(400 x 600mm)

Individually Packaged

3 STONE RANDOM BUNDLE

Villanova 80mm



Rialto Collection

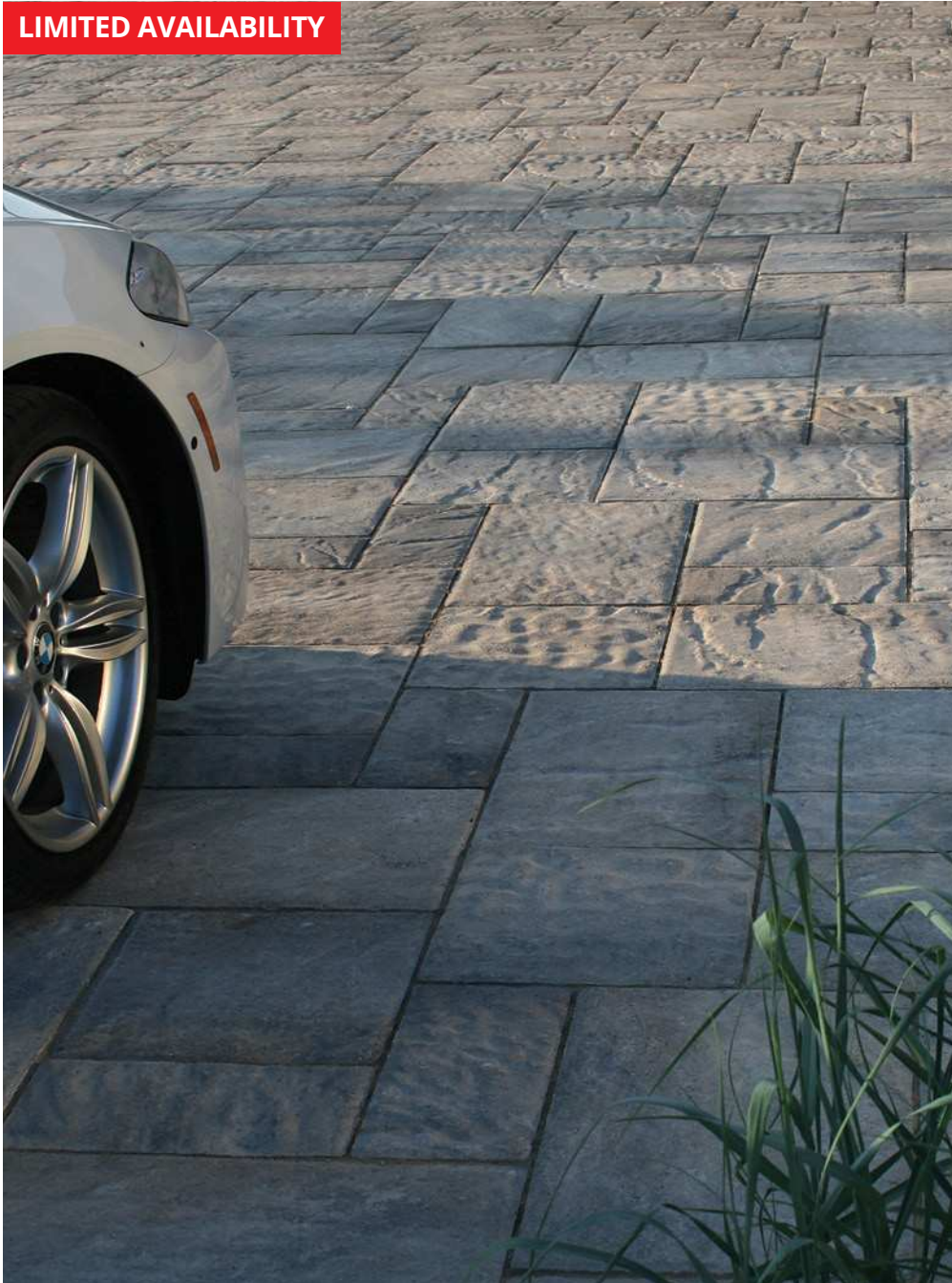

CHAMPAGNE



MARBLE GREY



ONYX

Onyx available in Rectangle Stone size only. Ideal for soldier coursing or banding.

Pavers: Villanova, Champagne



Square Stone
15.67 x 15.67"
(398 x 398mm)



Large Rectangle Stone
15.67 x 23.50"
(398 x 597mm)



Rectangle Stone
7.83 x 15.67"
(199 x 398mm)
Individually Packaged

2 STONE COMBO BUNDLE

Eterna 100mm



Eterna Collection

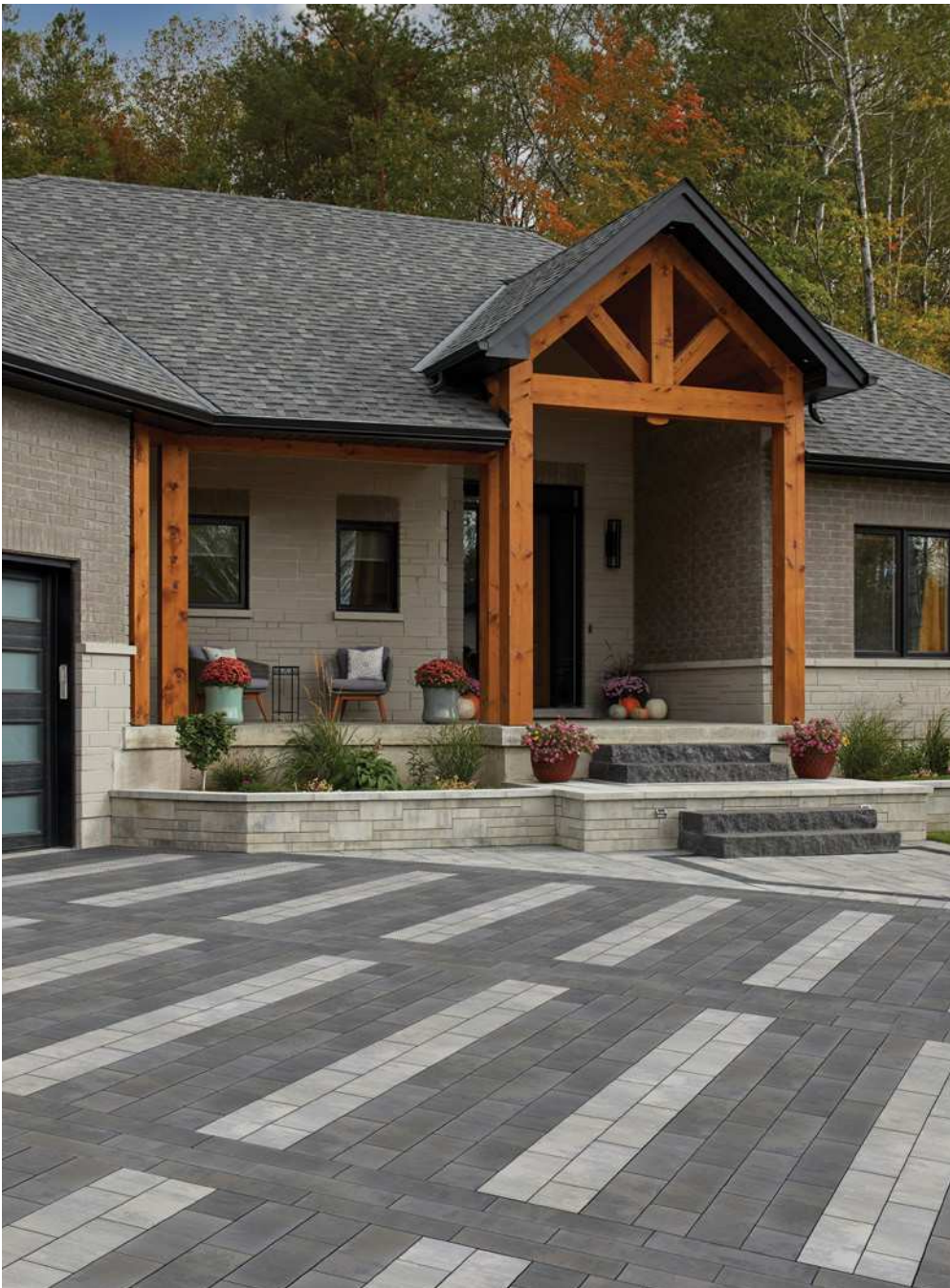

CLOUDBURST



LUNA



TWILIGHT

Pavers: Eterna, Luna and Cloudburst
Stone Masonry: Contempo, Dover
Clay Brick: Royal Gray, PRP



100x300 Stone
 3.94 x 11.81"
 (100 x 300mm)

Individually Packaged



100x400 Stone
 3.94 x 15.75"
 (100 x 400mm)

Individually Packaged



200x600 Stone
 7.87 x 23.62"
 (200 x 600mm)

Individually Packaged



400x600 Stone
 15.75 x 23.62"
 (400 x 600mm)

Individually Packaged

NOTE: When ordering Eterna, try to secure product from a single batch lot to reduce the risk of variability. Color and tonal consistency between different sizes and batch lots cannot be guaranteed.



Walls: Nueva® 150, Champagne with Champagne coping
Steps: Nueva® Step, Onyx
Slabs: Nueva® Slab, Champagne with Onyx border

Copings, Curbs & Steps

Oaks copings, curbs and steps have been designed to coordinate perfectly with our paver, slab and wall products to provide you with a harmonious design aesthetic.

Oasis 60mm



Nueva® Collection

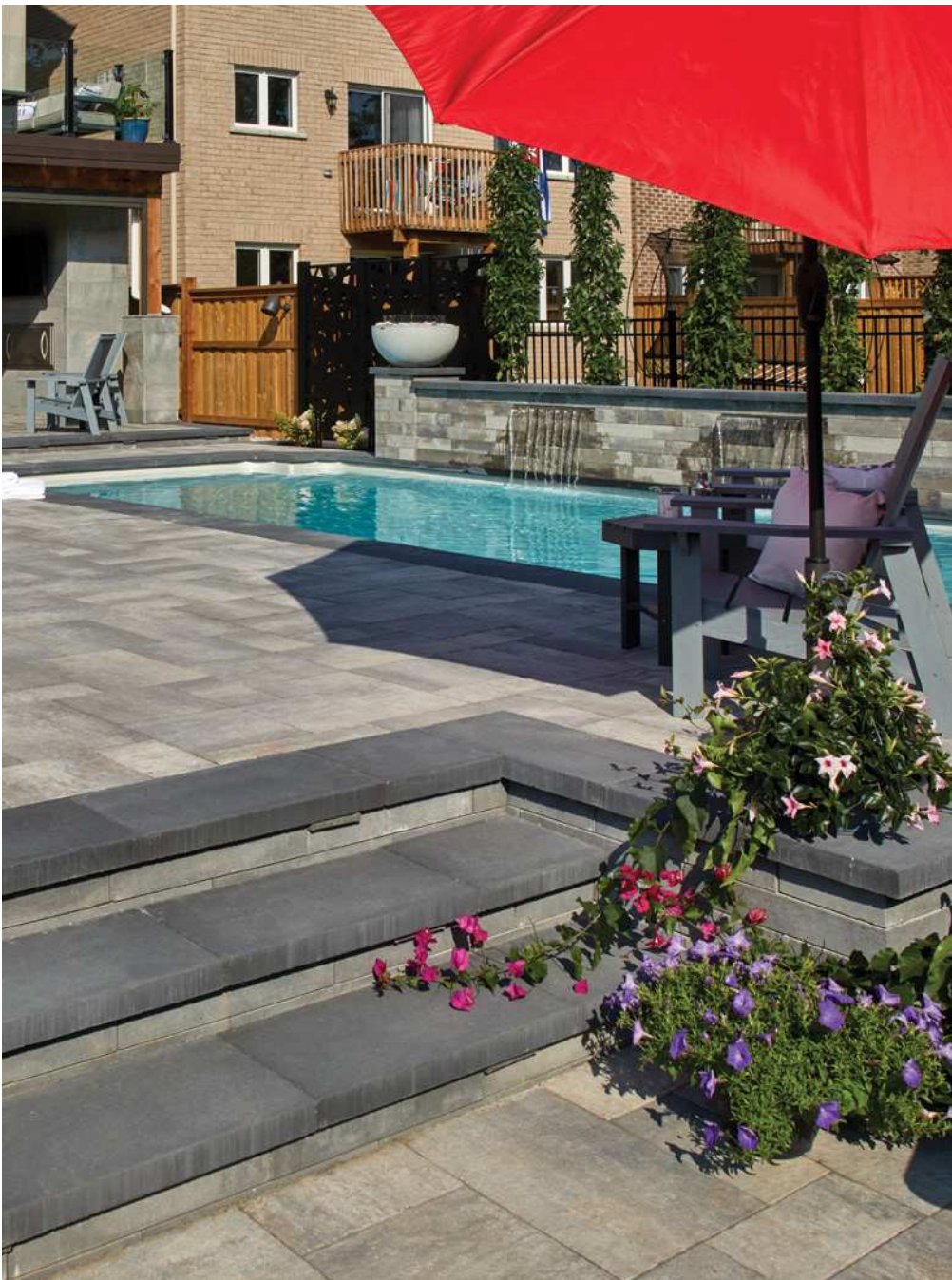

CHAMPAGNE



ONYX



CLOUDBURST



MARBLE GREY



MILANO

Step Treads: Oasis, Onyx
Slabs: Nueva® Slab, Champagne
Water Feature: Modan, Champagne with Oasis, Onyx caps



Coping Stone
 24 x 14.125"
 (610 x 360mm)
Individually Packaged

Cassina 70mm



Nueva® Collection



DOVER



ONYX

Coping: Cassina, Onyx
Slabs: Nueva® Slab, Marble Grey



8" Coping Stone
8 x 12"
(203 x 305mm)
LIMITED AVAILABILITY



12" Coping Stone NEW!
12 x 12"
(305 x 305mm)

Fronterra Curb



Rialto Collection



CHARTAN



GREYSTONE



ONYX

Curb: Fronterra, Greystone
Pavers: Nueva® Paver, Marble Grey with Onyx inset
Wall: Nueva® 150, Marble Grey with Marble Grey coping



Outside Width 14.6 x Inside Width 13 x 5.9 x 3.9"
 (Outside Width 372 x Inside Width 330 x 150 x 100mm)

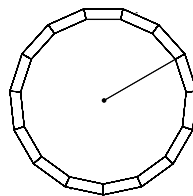

Circle
 15 pieces make a 1.8m (71")
 outside diameter circle.

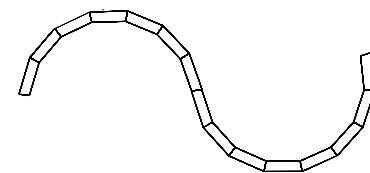

Serpentine
 To achieve larger radius applications,
 gap the inside (backside) of the curb
 unit accordingly.

Nueva® Curb



Nueva® Collection

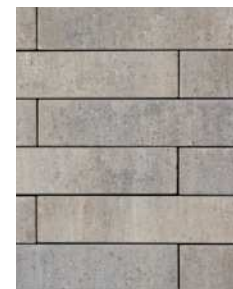

CHAMPAGNE



ONYX



CLOUDBURST



MARBLE GREY



MILANO

Curb: Nueva® Curb, Marble Grey
Pavers: Strassa, Marble Grey with Twilight border and accent
Wall: Nueva® 150, Marble Grey with Cloudburst coping



Curb Unit
23.6 x 4.9 x 3.9"
(600 x 125 x 100mm)

Aria Step



Rialto Collection



SMOOTH
TOP, BACK & ENDS



EMBOSSSED
FRONT FACE

CHAMPAGNE



SMOOTH
TOP, BACK & ENDS



EMBOSSSED
FRONT FACE

MACKINAW



SMOOTH
TOP, BACK & ENDS



EMBOSSSED
FRONT FACE

MARBLE GREY



SMOOTH
TOP, BACK & ENDS



EMBOSSSED
FRONT FACE

ONYX

Steps: Aria Step, Champagne
Slabs: Rialto 60mm, Champagne



Step Unit
47.24 x 6.5 x 15.75"
(1200 x 165 x 400mm)

Nueva® Step



Nueva® Collection



Steps: Nueva® Step, Onyx
Slabs: Molina® 60mm, Moraine with Twilight border



CHAMPAGNE



ONYX



CLOUDBURST



MARBLE GREY



MILANO



1200mm Step Unit
 47.24 x 5.91 x 15.75"
 (1200 x 150 x 400mm)

Smooth on all faces
 and ends.



Slabs: Nueva® Slab, Champagne with Onyx border
Pool Coping: Nueva® Coping, Champagne
Steps & Walls: Proterra™ Smooth, Natural



Walls

Beyond the average garden or retaining wall, our walls are functional, versatile, durable and beautiful! Build anything from seat walls to fireplaces, steps to pillars and outdoor kitchens. With coordinating walls, pavers, steps, and curbs, Oaks has everything you need.

Gardenia Linear

Legacy Collection



CHARTAN



GREYSTONE



SANDSTONE

Walls: Gardenia Linear, Greystone

Pavers: Market Paver 60mm, Sangria and Serengeti

Steps: Aria Step, Greyfield



Linear Unit
23.62 x 5.91 x 7.87"
(600 x 150 x 200mm)
Individually Packaged



90° Corner Unit
11.81 x 5.91 x 7.87"
(300 x 150 x 200mm)
Individually Packaged



For right and left corner info,
consult the Gardenia product
sheet available on our website.

Scan to view!

Laredo

Legacy Collection



Wall, Pillars & Fireplace: Laredo, Chartan with Onyx accent
Slabs: Rialto 60mm, Champagne



CHAMPAGNE



CHARTAN



GREYSTONE



ONYX



SANDALWOOD



Standard Unit
 11.44 x 3.82 x 7.63"
 (291 x 97 x 194mm)
Individually Packaged



Tapered Unit
 Outside Width 7.88 x Inside Width 6.06 x 3.82 x 7.63"
 (Outside Width 200 x Inside Width 154 x 97 x 194mm)
Individually Packaged

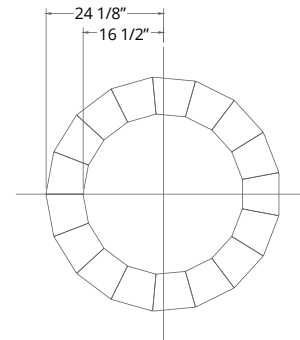

Laredo circle using Tapered Units
 17 units required for full circle.

Laredo Smooth

Nueva® Collection

FEATURES

Smooth faces with straight edges suits current design trends

Available in 3 colors that coordinate with other Oaks products

Individually packaged



Standard Unit
 11.44 x 3.82 x 7.63"
 (291 x 97 x 194mm)
Individually Packaged



CHAMPAGNE



MARBLE GREY



ONYX

Modan



Nueva® Collection



CHAMPAGNE



TWILIGHT



CLOUDBURST



MARBLE GREY



MILANO

Water Feature: Modan, Champagne
Slabs: Rialto 60mm, Champagne with Onyx border



330 Unit
 12.99 x 4.33 x 8.66"
 (330 x 110 x 220mm)



440 Unit
 17.32 x 4.33 x 8.66"
 (440 x 110 x 220mm)



550 Unit
 21.65 x 4.33 x 8.66"
 (550 x 110 x 220mm)



660 Unit
 25.98 x 4.33 x 8.66"
 (660 x 110 x 220mm)



Linear Unit
 17.32 x 4.33 x 8.66"
 (440 x 110 x 220mm)
Individually Packaged

4 BLOCK COMBO BUNDLE

*Concrete adhesive is required between rows for optimum stability.

Modeco One



Legacy Collection



Wall: Modeco One, Chartan



CHARTAN



GREYSTONE



ONYX



SANDSTONE



Standard Unit

Outside Width 7.25 x Inside Width 5.50 x 3.50 x 7.25"
 (Outside Width 184 x Inside Width 140 x 89 x 184mm)

Individually Packaged

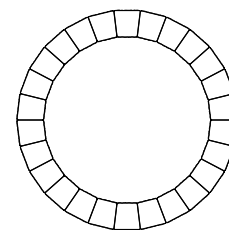

Tree Ring

26 pieces make a 1.5m (60") outside diameter circle.

*Concrete adhesive is required between rows for optimum stability.

Nueva® 75 Wall

Nueva® Collection



Wall: Nueva® 75, Champagne with Onyx coping



CHAMPAGNE



ONYX*



CLOUDBURST



MARBLE GREY



MILANO



16" Unit
15.75 x 2.95 x 11.81"
(400 x 75 x 300mm)



20" Unit
19.69 x 2.95 x 11.81"
(500 x 75 x 300mm)



20" Corner/End Unit
19.69 x 2.95 x 11.81"
(500 x 75 x 300mm)



24" Unit
23.62 x 2.95 x 11.81"
(600 x 75 x 300mm)



Coping Unit
23.62 x 2.95 x 13.38"
(600 x 75 x 340mm)
**Packaged with
End Coping Units**



End Coping Unit
23.62 x 2.95 x 13.38"
(600 x 75 x 340mm)
**Packaged with
Coping Units**

4 BLOCK COMBO BUNDLE

*Onyx available in Combo Bundle and Coping Bundle.

Nueva® 150 Wall

Nueva® Collection

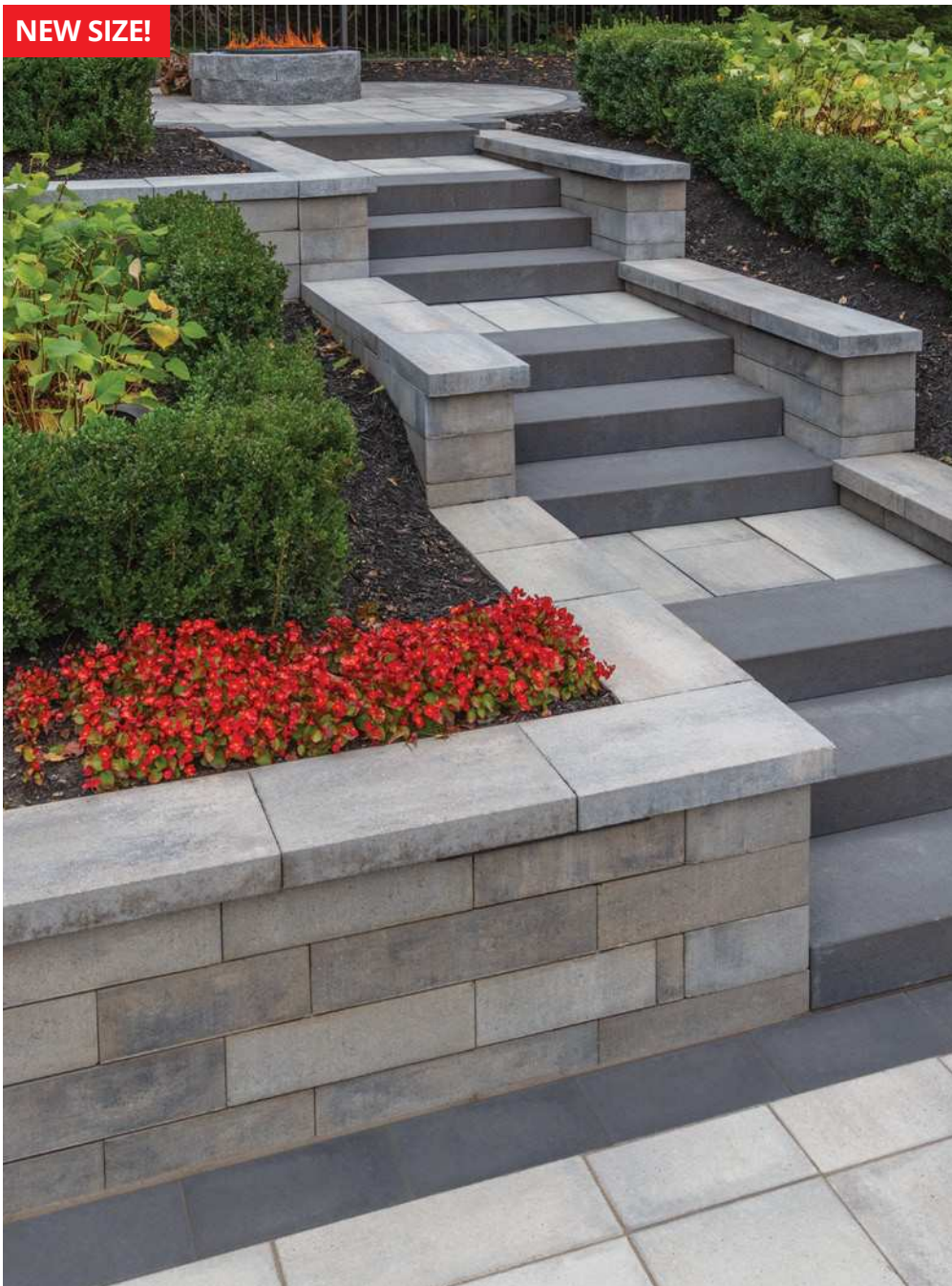

Walls: Nueva® 150, Champagne with Champagne coping
Steps: Nueva® Step, Onyx
Slabs: Nueva® Slab, Champagne with Onyx border



CHAMPAGNE



MILANO



CLOUDBURST



ONYX*



MARBLE GREY



Coping Unit
 23.62 x 2.95 x 13.38"
 (600 x 75 x 340mm)
Packaged with
End Coping Units



End Coping Unit
 23.62 x 2.95 x 13.38"
 (600 x 75 x 340mm)
Packaged with
Coping Units

*Onyx available in Coping and End Coping only.



16" Unit
 15.75 x 5.91 x 11.81"
 (400 x 150 x 300mm)



20" Unit
 19.69 x 5.91 x 11.81"
 (500 x 150 x 300mm)



20" Corner/End Unit
 19.69 x 5.91 x 11.81"
 (500 x 150 x 300mm)



24" Unit
 23.62 x 5.91 x 11.81"
 (600 x 150 x 300mm)

4 BLOCK COMBO BUNDLE

NEW CORNER/COLUMN UNIT



Corner/Column Unit
 7.87 x 5.91 x 11.81"
 (200 x 150 x 300mm)
Individually Packaged



Makes a 19 5/8 x 19 5/8"
 (500 x 500mm)
 square column

Ortana

Legacy Collection



CHAMPAGNE



SANDALWOOD



DESERT



TIMBERWOOD



MARBLE GREY



ONYX

Walls, Pillars & Firepit: Ortana, Timberwood
Wall Caps: Ortana, Desert
Slabs: Molina® 60mm, Moraine with Twilight border



Standard Unit
 7.87 x 5.91 x 11.81"
 (200 x 150 x 300mm)
Individually Packaged



Tapered Unit
 Front Width 7.87 x Back Width 5.91 x 5.91 x 11.81"
 (Front Width 200 x Back Width 150 x 150 x 300mm)
Individually Packaged



90° Corner Unit
 11.81 x 5.91 x 7.87"
 (300 x 150 x 200mm)
Individually Packaged



1' Split-Face Coping Unit
 11.81 x 2.95 x 11.81"
 (300 x 75 x 300mm)
Individually Packaged
Not available in Onyx



2' Split-Face Coping Unit
 24.02 x 2.95 x 11.81"
 (610 x 75 x 300mm)
Individually Packaged

For right and left corner info, consult the Ortana product sheet available on our website.
Scan to view!



Proterra™ Smooth



Nueva® Collection



GREYFIELD, SMOOTH



NATURAL, SMOOTH

Wall: Proterra™ Smooth, Natural



Standard Unit
39.37 x 7.28 x 14.76"
(1000 x 185 x 375mm)

Smooth on both faces
Individually Packaged



Double Unit
39.37 x 7.28 x 29.52"
(1000 x 185 x 750mm)

Smooth on one face,
Split on one face

**Packaged with
Standard Unit**



Triple Unit
39.37 x 7.28 x 44.29"
(1000 x 185 x 1125mm)

Smooth on both faces
Individually Packaged



Standard Corner Unit
39.37 x 7.28 x 14.76"
(1000 x 185 x 375mm)

Smooth on both faces
and closed end
Individually Packaged



Coping Corner/End Unit
39.37 x 7.28 x 16.92"
(1000 x 185 x 430mm)

Smooth on both faces
and closed end
Individually Packaged



Coping-Step Unit
39.37 x 7.28 x 16.92"
(1000 x 185 x 430mm)

Smooth on both faces
Individually Packaged

Note 1: Colored wall units also available as custom order. Minimum quantities apply.

Note 2: For right and left corner info, consult the Proterra™ product sheet available on our website.

Proterra™ Split



Legacy Collection

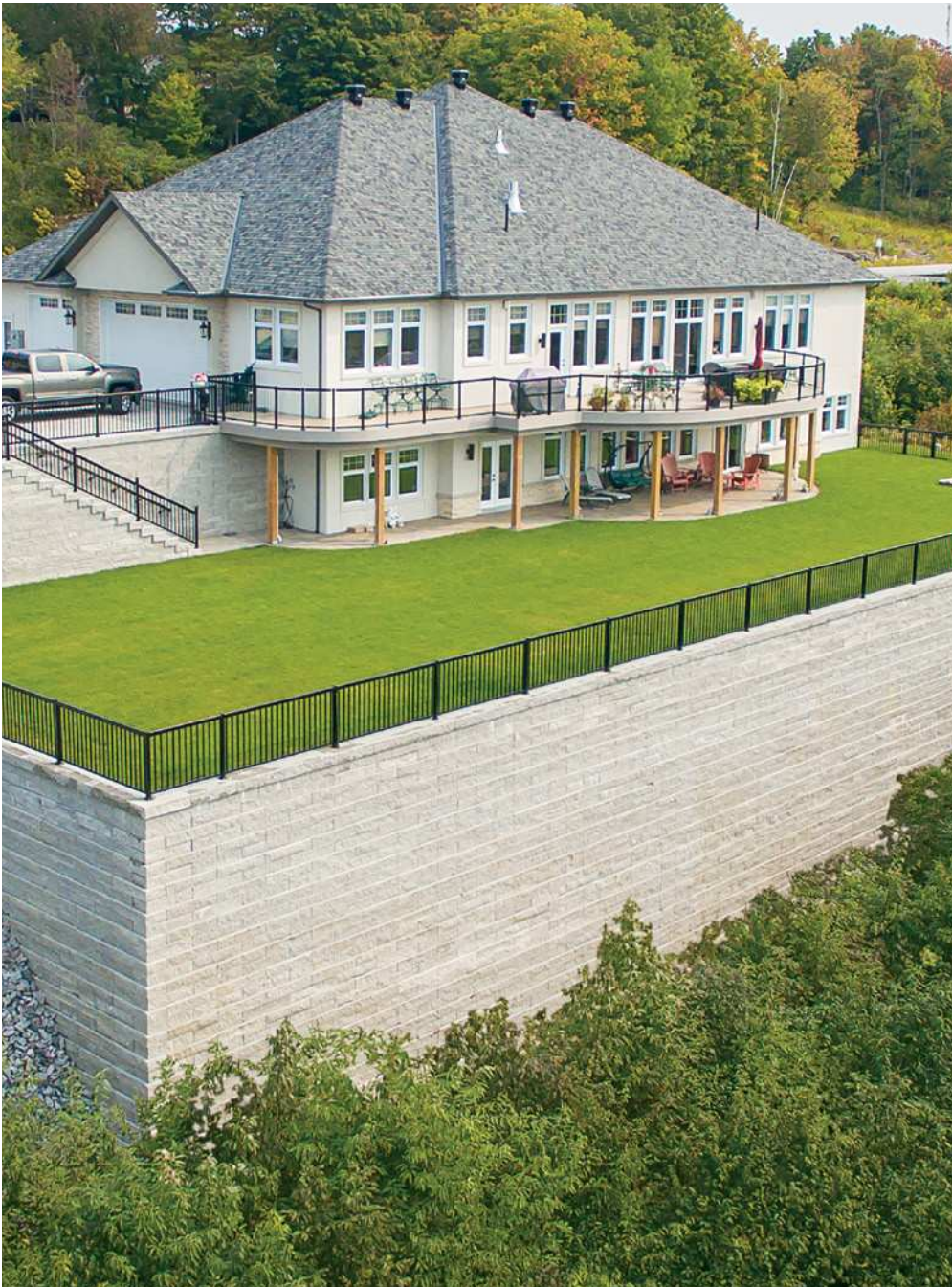

GREYFIELD, SPLIT







NATURAL, SPLIT



TIMBERWOOD, SPLIT

Walls: Proterra™ Split, Natural

				
Standard Unit 39.37 x 7.28 x 14.76" (1000 x 185 x 375mm)	Double Unit 39.37 x 7.28 x 29.52" (1000 x 185 x 750mm)	Standard Corner Unit 34.44 x 7.28 x 14.76" (875 x 185 x 375mm)	Coping Corner/End Unit 34.44 x 7.28 x 16.92" (875 x 185 x 430mm)	Coping-Step Unit 39.37 x 7.28 x 16.92" (1000 x 185 x 430mm)
Two units Split on one face, Smooth on one face One unit Split on both faces Individually Packaged	Split on one face, Smooth on one face Packaged with Standard Unit	Split on front face and closed end Individually Packaged	Split on front face and closed end Individually Packaged	Split on one face, Smooth on one face Individually Packaged

Note 1: Colored wall units also available as custom order. Minimum quantities apply.

Note 2: For right and left corner info, consult the Proterra™ product sheet available on our website.

Note 3: Triple unit only available as Smooth. See Proterra™ Smooth page 45.



Planning & Specifications

Your outdoor space is your canvas. With an impressive variety of colors, textures, shapes and patterns designed to work together in a myriad of design combinations, Oaks Landscape Products give you all the tools you need to inspire your project and start planning something spectacular. The creative process can be daunting. We can help!

Layout Possibilities

Colonnade 60mm

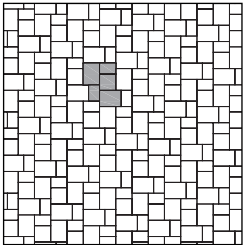

Pattern C
27% (6x9)
20% (9x9)
53% (9x12)

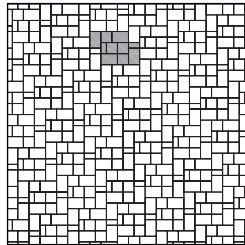

Pattern G
10% (3x6)
40% (6x6)
50% (6x9)

Classic Paver & Market Paver 60 & 80mm

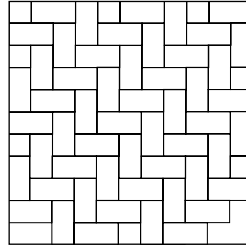

**Pattern A -
Herringbone**
100% (4x8)

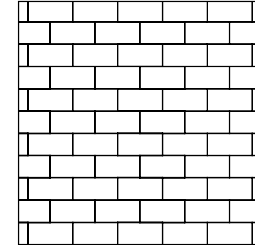

**Pattern B -
Half Running Bond**
100% (4x8)

Molina® 60 & 80mm

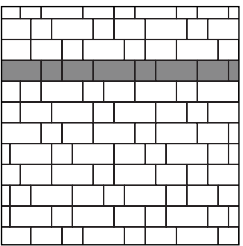

**Pattern A -
Running Bond**
25% (12x12)
25% (12x18)
50% (12x24)

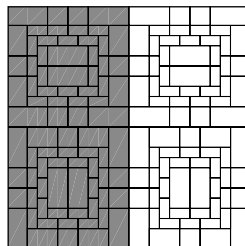

**Pattern D -
Patchwork**
33.2% (6x12)
16.7% (12x12)
16.7% (12x18)
33.4% (12x24)

Nueva® Slab & Paver 60 & 80mm

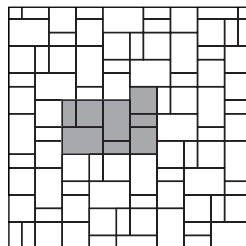

**Pattern A -
L-Shape**
20% (8x16)
40% (16x16)
40% (16x24)

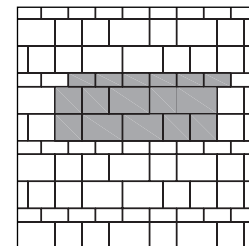

**Pattern C -
Running Bond**
20% (8x16)
40% (16x16)
40% (16x24)

Nueva® XL Slab 60mm

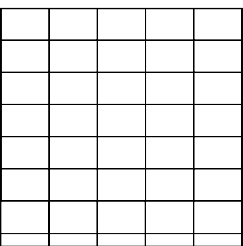

**Pattern A -
Stack Bond**
100% (24x36)

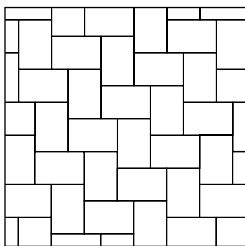

**Pattern D -
Herringbone**
100% (24x36)

Rialto 60 & 80mm

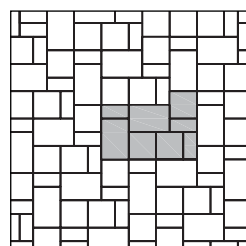

**Pattern B -
L-shape**
20% (8x16)
40% (16x16)
40% (16x24)

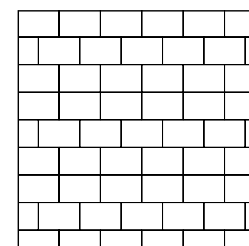

**Pattern F -
Staggered Running Bond**
100% (16x24)

Layout Possibilities

More laying patterns are available on our website!
 Visit OAKSpavers.com/en/resource-search



Strassa 60mm

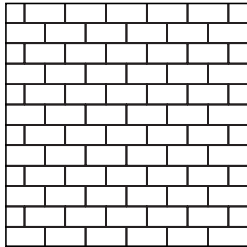

**Pattern A -
Half Running Bond**
100% (6x12)

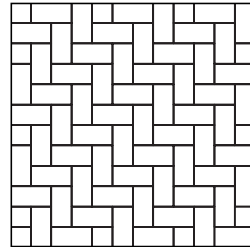

**Pattern C -
Herringbone**
100% (6x12)

Villanova 80mm

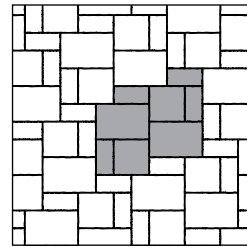

**Pattern A -
Cluster**
28% (Rectangle)
29% (Square)
43% (Large Rectangle)

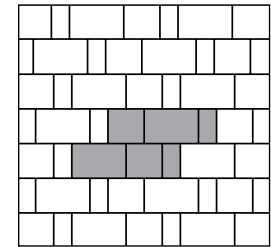

**Pattern F -
Running Bond**
17% (Rectangle)
33% (Square)
50% (Large Rectangle)

Ridgefield Plus & Smooth 70mm

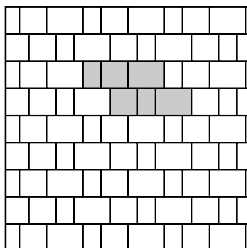

**Pattern C -
Running Bond**
22% (8x12)
33% (12x12)
45% (12x16)

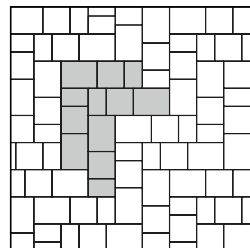

**Pattern E - Combo
Bundle Herringbone**
22% (8x12)
33% (12x12)
45% (12x16)

Eterna 100mm

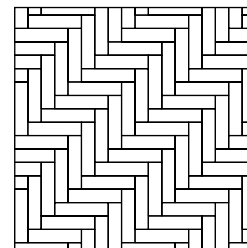

**Pattern G -
Herringbone**
100% (100x400)

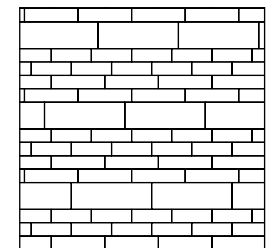

**Pattern M -
Running Bond**
33.3% (100x300)
33.3% (100x400)
33.3% (200x600)

Enviro Midori 80mm

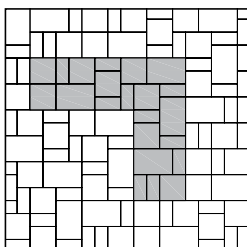

**Pattern D -
Random Herringbone**
26% (5x10)
42% (10x10)
32% (10x15)

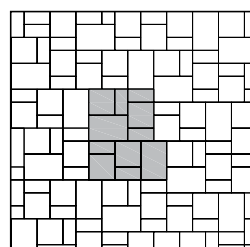

**Pattern E -
Random Cluster**
26% (5x10)
42% (10x10)
32% (10x15)

1 ONE SAND

The only polymeric sand you need.



Canvas
Beige

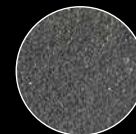

Absolute
Black



Granite
Grey



Available in 3 colors!
 50lb (22.7kg) bag | 63 bags/skid

SLAB & PAVER RECOMMENDED USES (RESIDENTIAL)

Product Matrix



PRODUCT	THICKNESS	SIZES	POOL DECK	PATIO/WALKWAY	DRIVEWAY	PERMEABLE	EliteFinish™	ColorBold™
Classic Paver	60mm	Standard Bundle	✓	✓	✓			
		Combo Bundle	✓	✓	✓			
Colonnade	60mm	6x9 Stone	✓	✓	✓			
		9x9 Stone	✓	✓	✓			
		9x12 Stone	✓	✓	✓			
Market Paver	60mm	4x8 Stone	✓	✓	✓		✓	✓
		Combo Bundle	✓	✓			✓	✓
Molina®	60mm	6x12 Stone	✓	✓			✓	✓
		12x24 Stone	✓	✓			✓	✓
		24x24 Stone	✓	✓			✓	✓
		Random Bundle	✓	✓				
Nueva® Slab	60mm	8x16 Small Rectangle	✓	✓				
		12x24 Rectangle	✓	✓				
		24x36 Stone	✓	✓				
Rialto	60mm	Random Bundle	✓	✓				
		8x16 Stone	✓	✓				
		16x24 Stone	✓	✓				
Strassa	60mm	6x12 Stone	✓	✓	✓	✓	✓	
Ridgefield Plus & Ridgefield Smooth	70mm	Large Combo Bundle	✓	✓	✓			
		8x12 Stone	✓	✓	✓			
Enviro Midori	80mm	Random Bundle		✓	✓	✓		
Market Paver	80mm	4x8 Stone		✓	✓		✓	✓
		Combo Bundle		✓	✓		✓	✓
Molina®	80mm	6x12 Stone		✓	✓		✓	✓
		12x24 Stone		✓	✓		✓	✓
		Random Bundle		✓	✓			
Nueva® Paver	80mm	8x16 Small Rectangle		✓	✓			
		16x32 Large Rectangle		✓				
		Random Bundle		✓	✓			
Rialto	80mm	8x16 Stone		✓	✓			
		16x24 Stone		✓	✓			
		Random Bundle		✓	✓			
Villanova	80mm	Combo Bundle		✓	✓			
		Rectangle Stone		✓	✓			
Eterna	100mm	100x300 Stone			✓		✓	
		100x400 Stone			✓		✓	
		200x600 Stone			✓		✓	
		400x600 Stone			✓		✓	

NOTE: Thicker units can be used for pool deck and patio/walkway applications. Our recommendations are based on the availability of thinner alternatives.

Product Matrix

PRODUCT	SIZES	RECOMMENDED USES					FUNCTIONAL FEATURES			
		GARDEN WALL	RETAINING WALL	CURB	PILLAR	TREE RING	FEATURE*	DOUBLE-SIDED	BUILT-IN INTERLOCK	CORED
Gardenia Linear	Linear Unit	√		√					√	
Laredo	Standard Unit	√		√	√		√	√		
	Tapered Unit	√				√	√	√		
Laredo Smooth	Standard Unit	√		√	√		√	√		
Modan	Combo Bundle	√		√			√			
	Linear Unit	√		√	√		√			
Modeco One	Standard Unit	√				√		√		
Nueva® 75 Wall	Combo Bundle	√					√	√	√	
Nueva® 150 Wall	Combo Bundle		√				√	√	√	√
	Corner/Column Unit		√		√		√	√		
Ortana	Standard Unit	√	√		(Corner Unit)		√	√	√	
	Tapered Unit	√	√				√		√	
Proterra™ Smooth	Standard Unit		√					√	√	
	Double Unit		√						√	
	Triple Unit		√						√	
Proterra™ Split	Standard Unit		√						√	
	Double Unit		√						√	

*Feature = Fire pit/fire table, water feature, outdoor kitchen

WALL TYPE/ALIGNMENT & INSTALLATION

PRODUCT	SIZES	STRAIGHT WALL	CURVED WALL	FREE-STANDING	SINGLE-DEPTH GRAVITY	MULTI-DEPTH GRAVITY	STABILIZED BACKFILL	GEOGRID REINFORCED	MACHINE INSTALL
Gardenia Linear	Linear Unit	√			√				
Laredo	Standard Unit	√		√	√				
	Tapered Unit		√	√	√				
Laredo Smooth	Standard Unit	√		√	√				
Modan	Combo Bundle	√			√				
	Linear Unit	√			√				
Modeco One	Standard Unit	√	√	√	√				
Nueva® 75 Wall	Combo Bundle	√		√	√		√	√	
Nueva® 150 Wall	Combo Bundle	√		√	√		√	√	
	Corner/Column Unit	√		√	√				
Ortana	Standard Unit	√		√	√		√	√	
	Tapered Unit		√		√		√	√	
Proterra™ Smooth	Standard Unit	√		√	√	√	√	√	√
	Double Unit	√		√	√	√	√	√	√
	Triple Unit	√		√	√	√	√	√	√
Proterra™ Split	Standard Unit	√		√	√	√	√	√	√
	Double Unit	√		√	√	√	√	√	√

Packaging Specifications

	Per Full Bundle				Per Layer				Per Section			
CLASSIC PAVER 60mm	Sq. Ft.	Lin. Ft.	Pieces	Wt. (lbs)	Layers	Sq. ft.	Pieces	Wt. (lbs)	Section	Sq. Ft.	Pieces	Wt. (lbs)
STANDARD BUNDLE 4x4, 4x8	106	157 (Sol) 314 (Sa)	18 (4x4) 477 (4x8)	2900	9	11.8	2 (4x4) 53 (4x8)	322	6	17.7	3 (4x4) 79 (4x8)	483
COLONNADE 60mm	Sq. Ft.	Lin. Ft.	Pieces	Wt. (lbs)	Layers	Sq. ft.	Pieces	Wt. (lbs)	Section	Sq. Ft.	Pieces	Wt. (lbs)
COMBO BUNDLE 3x6, 6x6	104	35 (3x6) 177 (6x6)	144 (3x6) 360 (6x6)	2925	9	11.6	16 (3x6) 40 (6x6)	325	8	13	18 (3x6) 45 (6x6)	366
6x9 Stone	105	141.7 (Sol) 212.6 (Sa)	288	2826	9	11.7	32	314	8	13.1	36	353
9x9 Stone	98	132.9 (Sol)	180	2750	9	10.9	20	306	5	19.6	36	550
9x12 Stone	104	106.3 (Sol) 141.7 (Sa)	144	2936	9	11.6	16	326	4	26	36	734
MARKET PAVER 60mm	Sq. Ft.	Lin. Ft.	Pieces	Wt. (lbs)	Layers	Sq. ft.	Pieces	Wt. (lbs)	Section	Sq. Ft.	Pieces	Wt. (lbs)
4x8 Stone NEW!	104.6	159.4 (Sol) 318.8 (Sa)	486	3020	9 †	11.6	54	336	6	17.4	81	503
MOLINA® 60mm	Sq. Ft.	Lin. Ft.	Pieces	Wt. (lbs)	Layers	Sq. ft.	Pieces	Wt. (lbs)	Section	Sq. Ft.	Pieces	Wt. (lbs)
COMBO BUNDLE 12x12, 12x18, 12x24	93	94.5 (Sa)	24 (12x12) 16 (12x18) 24 (12x24)	2790	8 †	11.6	3 (12x12) 2 (12x18) 3 (12x24)	349	-	-	-	-
6x12 Stone	93	94.5 (Sol) 189 (Sa)	192	2740	8 †	11.6	24	343	4	23.3	48	685
12x24 Stone	93	47.3 (Sol) 94.5 (Sa)	48	2796	8 †	11.6	6	350	2	46.5	24	1398
24x24 Stone	77.5	39.4 (Sol)	20	2346	10 †	7.8	2	235	2	38.8	10	1173
NUEVA® SLAB 60mm	Sq. Ft.	Lin. Ft.	Pieces	Wt. (lbs)	Layers	Sq. ft.	Pieces	Wt. (lbs)	Section	Sq. Ft.	Pieces	Wt. (lbs)
RANDOM BUNDLE 8x16, 16x16, 16x24	103.4	78.7 (Sa)	24 (8x16) 24 (16x16) 16 (16x24)	2940	8 †	12.9	3 (8x16) 3 (16x16) 2 (16x24)	368	-	-	-	-
8x16 Small Rectangle	103.4	78.7 (Sol) 157.4 (Sa)	120	2912	8 †	12.9	15	364	3	34.5	40	971
12x24 Rectangle	104.6	53.2 (Sol) 106.3 (Sa)	54	3017	9 †	11.6	6	335	2	52.3	27	1509
NUEVA® XL SLAB 60mm	Sq. Ft.	Lin. Ft.	Pieces	Wt. (lbs)	Layers	Sq. ft.	Pieces	Wt. (lbs)	Section	Sq. Ft.	Pieces	Wt. (lbs)
24x36 Stone	116.3	39.4 (Sol) 59.1 (Sa)	20	3200	10 †	11.6	2	320	2	58.2	10	1600
RIALTO 60mm	Sq. Ft.	Lin. Ft.	Pieces	Wt. (lbs)	Layers	Sq. ft.	Pieces	Wt. (lbs)	Section	Sq. Ft.	Pieces	Wt. (lbs)
RANDOM BUNDLE 8x16, 16x16, 16x24	103.4	78.7 (Sa)	24 (8x16) 24 (16x16) 16 (16x24)	2940	8 †	12.9	3 (8x16) 3 (16x16) 2 (16x24)	368	-	-	-	-
8x16 Stone	103.4	78.7 (Sol) 157.4 (Sa)	120	2912	8 †	12.9	15	364	3	34.5	40	971
16x24 Stone	103.4	52.5 (Sol) 78.7 (Sa)	40	2952	8 †	12.9	5	369	-	-	-	-
STRASSA 60mm	Sq. Ft.	Lin. Ft.	Pieces	Wt. (lbs)	Layers	Sq. ft.	Pieces	Wt. (lbs)	Section	Sq. Ft.	Pieces	Wt. (lbs)
6x12 Stone NEW!	104.7	106.3 (Sol) 212.6 (Sa)	216	2880	9 †	11.6	24	320	4	26.2	54	720
RIDGEFIELD PLUS 70mm	Sq. Ft.	Lin. Ft.	Pieces	Wt. (lbs)	Layers	Sq. ft.	Pieces	Wt. (lbs)	Section	Sq. Ft.	Pieces	Wt. (lbs)
LARGE COMBO BUNDLE 8x12, 12x12, 12x16	93	94.5 (Sa)	32 each	3004	8	11.6	4 each	376	4	23.3	8 each	751
8x12 Stone	104	105 (Sol) 157.5 (Sa)	160	3340	8	13	20	418	4	26	40	835
RIDGEFIELD SMOOTH 70mm	Sq. Ft.	Lin. Ft.	Pieces	Wt. (lbs)	Layers	Sq. ft.	Pieces	Wt. (lbs)	Section	Sq. Ft.	Pieces	Wt. (lbs)
LARGE COMBO BUNDLE 8x12, 12x12, 12x16	93	94.5 (Sa)	32 each	3004	8 †	11.6	4 each	376	-	-	-	-
8x12 Stone	104	105 (Sol) 157.5 (Sa)	160	3340	8 †	13	20	418	4	26	40	835

NOTE: For Combo and Random packaged products, all stones used as sailor soldier course.

(Sol) = Soldier

(Sa) = Sailor

† = Packaged with mesh between layers

Packaging Specifications

	Per Full Bundle					Per Layer				Per Section			
ENVIRO MIDORI 80mm	Sq. Ft.	Lin. Ft.	Pieces	Wt. (lbs)	Layers	Sq. ft.	Pieces	Wt. (lbs)	Section	Sq. Ft.	Pieces	Wt. (lbs)	
RANDOM BUNDLE 5x10, 10x10, 10x15	74.4	94.5 (Sa)	60 (5x10) 54 (10x10) 24 (10x15)	2675	6 †	12.4	10 (5x10) 9 (10x10) 4 (10x15)	446	-	-	-	-	
MARKET PAVER 80mm	Sq. Ft.	Lin. Ft.	Pieces	Wt. (lbs)	Layers	Sq. ft.	Pieces	Wt. (lbs)	Section	Sq. Ft.	Pieces	Wt. (lbs)	
4x8 Stone	69.8	106.3 (Sol) 212.6 (Sa)	324	2684	6 †	11.6	54	447	6	11.6	54	447	
MOLINA® 80mm	Sq. Ft.	Lin. Ft.	Pieces	Wt. (lbs)	Layers	Sq. ft.	Pieces	Wt. (lbs)	Section	Sq. Ft.	Pieces	Wt. (lbs)	
COMBO BUNDLE 12x12, 12x18, 12x24	69.8	70.8 (Sa)	18 (12x12) 12 (12x18) 18 (12x24)	2720	6 †	11.6	3 (12x12) 2 (12x18) 3 (12x24)	453	-	-	-	-	
6x12 Stone	69.8	70.8 (Sol) 141.7 (Sa)	144	2689	6 †	11.6	24	448	4	17.6	36	672	
12x24 Stone	69.8	35.4 (Sol) 70.8 (Sa)	36	2778	6 †	11.6	6	463	-	-	-	-	
NUEVA® PAVER 80mm	Sq. Ft.	Lin. Ft.	Pieces	Wt. (lbs)	Layers	Sq. ft.	Pieces	Wt. (lbs)	Section	Sq. Ft.	Pieces	Wt. (lbs)	
RANDOM BUNDLE 8x16, 16x16, 16x24	77.5	59.1 (Sa)	18 (8x16) 18 (16x16) 12 (16x24)	2930	6 †	12.9	3 (8x16) 3 (16x16) 2 (16x24)	488	-	-	-	-	
8x16 Small Rectangle	77.5	59.1 (Sol) 118.2 (Sa)	90	2902	6 †	12.9	15	484	3	25.8	30	967	
16x32 Large Rectangle	83	31.5 (Sol) 63 (Sa)	24	3136	8 †	10.4	3	392	3	27.7	8	1045	
RIALTO 80mm	Sq. Ft.	Lin. Ft.	Pieces	Wt. (lbs)	Layers	Sq. ft.	Pieces	Wt. (lbs)	Section	Sq. Ft.	Pieces	Wt. (lbs)	
RANDOM BUNDLE 8x16, 16x16, 16x24	77.5	59.1 (Sa)	18 (8x16) 18 (16x16) 12 (16x24)	2930	6 †	12.9	3 (8x16) 3 (16x16) 2 (16x24)	488	-	-	-	-	
8x16 Stone	77.5	59.1 (Sol) 118.2 (Sa)	90	2902	6 †	12.9	15	484	3	25.8	30	967	
16x24 Stone	77.5	39.4 (Sol) 59.1 (Sa)	30	2930	6 †	12.9	5	488	-	-	-	-	
VILLANOVA 80mm	Sq. Ft.	Lin. Ft.	Pieces	Wt. (lbs)	Layers	Sq. ft.	Pieces	Wt. (lbs)	Section	Sq. Ft.	Pieces	Wt. (lbs)	
COMBO BUNDLE Square, Large Rectangle	76.5	58.8 (Sa)	18 each	2898	6	12.8	3 each	483	3	25.5	6 each	966	
Rectangle Stone	76.5	58.8 (Sol) 117.5 (Sa)	90	2856	6	12.8	15	476	3	25.5	30	952	
ETERNA 100mm	Sq. Ft.	Lin. Ft.	Pieces	Wt. (lbs)	Layers	Sq. ft.	Pieces	Wt. (lbs)	Section	Sq. Ft.	Pieces	Wt. (lbs)	
100x300 Stone	64	65 (Sol) 194.9 (Sa)	198	2979	6 †	10.7	33	497	3	21.3	66	993	
100x400 Stone	57	43.3 (Sol) 173.2 (Sa)	132	2648	6 †	9.5	22	441	2	28.5	66	1324	
200x600 Stone	62	31.5 (Sol) 94.5 (Sa)	48	2889	6 †	10.3	8	482	-	-	-	-	
400x600 Stone	64.6	32.8 (Sol) 49.2 (Sa)	25	3012	5 †	12.9	5	602	-	-	-	-	

NOTE: For Combo and Random packaged products, all stones used as sailor soldier course.

(Sol) = Soldier

(Sa) = Sailor

† = Packaged with mesh between layers

Packaging Specifications

COPINGS	Per Full Bundle					Per Layer				Per Section				Per Pc.	
	Sq. Ft.	Lin. Ft.	Pieces	Wt. (lbs)	Layers	Sq. Ft.	Lin. Ft.	Pieces	Wt. (lbs)	Sections	Sq. Ft.	Lin. Ft.	Pieces	Wt. (lbs)	Wt./pc. (lbs)
Oasis Coping	85	72	36	2448	9 †	9.5	8	4	272	2	42.5	36	18	272	68
8" Cassina Coping	52	52	78	1716	3	17.3	17.3	26	572	-	-	-	-	-	22
12" Cassina Coping NEW!	60	60	60	1980	2	30	30	30	990	3	20	20	20	660	33
CURBS & STEPS	Sq. Ft.	Lin. Ft.	Pieces	Wt. (lbs)	Layers	Sq. Ft.	Lin. Ft.	Pieces	Wt. (lbs)	Sections	Sq. Ft.	Lin. Ft.	Pieces	Wt. (lbs)	Wt./pc. (lbs)
Fronterra Curb	-	125.1	108	2948	4	-	31.3	27	737	-	-	-	-	-	27.3
Nueva® Curb	-	126	64	2486	4	-	31.5	16	621.5	2	-	63	32	1243	38.8
Aria Step	8.5 (face) 20.6 (top)	15.8	4	1600	1	-	-	-	-	-	-	-	-	-	400
Nueva® Step	7.8 (face) 20.6 (top)	15.7	4	1440	1	-	-	-	-	-	-	-	-	-	360

GARDENIA LINEAR	Per Full Bundle				Per Layer				Per Section			
	Area/bundle (face ft.)	Lin. Ft.	Pieces	Wt. (lbs)	Layers	Sq. Ft.	Pieces	Wt. (lbs)	Sections	Sq. Ft.	Pieces	Wt. (lbs)
Linear Unit	31	63	32	2848	4	7.8	8	712	2	15.5	16	1424
90° Corner Unit	51.6	104.4	64	2880	4	12.9	16	720	2	25.8	32	1440
LAREDO	Area/bundle (face ft.)	Lin. Ft.	Pieces	Wt. (lbs)	Layers	Sq. Ft.	Pieces	Wt. (lbs)	Sections	Sq. Ft.	Pieces	Wt. (lbs)
Standard Unit	30.3	95.3	100	2800	5	6.1	20	560	4	7.6	25	700
Tapered Unit	27.1 (Outside)	75.8	150	2700	5	5.4 (Outside)	30	540	6	5.2 (Outside)	25	450
LAREDO SMOOTH	Area/bundle (face ft.)	Lin. Ft.	Pieces	Wt. (lbs)	Layers	Sq. Ft.	Pieces	Wt. (lbs)	Sections	Sq. Ft.	Pieces	Wt. (lbs)
Standard Unit	25.5	80	84	2352	6	4.3	14	392	4	6.4	21	588
MODAN	Area/bundle (face ft.)	Lin. Ft.	Pieces	Wt. (lbs)	Layers	Sq. Ft.	Pieces	Wt. (lbs)	Sections	Sq. Ft.	Pieces	Wt. (lbs)
COMBO BUNDLE 330 Unit, 440 Unit, 550 Unit, 660 Unit	28.1	78	12 each	2884	3 †	9.4	4 each	961	-	-	-	-
Linear Unit	25 (Wall) 37.5 (Col)	69.3 (Wall) 104 (Col)	48	2544	3 †	8.3 (Wall) 12.5 (Col)	16	848	2	12.5	24	1272
MODECO ONE	Area/bundle (face ft.)	Lin. Ft.	Pieces	Wt. (lbs)	Layers	Sq. Ft.	Pieces	Wt. (lbs)	Sections	Sq. Ft.	Pieces	Wt. (lbs)
Standard Unit	27.9 (Straight) 31.7 (Outside) 24.1 (Inside)	95.7 (Straight) 108.7 (Outside) 82.7 (Inside)	180	2520	6	4.7 (Straight) 5.3 (Outside) 4 (Inside)	30	420	-	-	-	-
NUEVA® 75 WALL	Area/bundle (face ft.)	Lin. Ft.	Pieces	Wt. (lbs)	Layers	Sq. Ft.	Pieces	Wt. (lbs)	Sections	Sq. Ft.	Pieces	Wt. (lbs)
COMBO BUNDLE 16" Unit, 20" Unit, 20" Corner/End Unit, 24" Unit	19.5	78	12 each	2589	6	3.3	2 each	432	-	-	-	-
Coping Unit Coping End Unit	11.6	47.2	16 (Reg) 8 (End)	1872	8 †	1.5	2 (Reg) 1 (End)	234	-	-	-	-
NUEVA® 150 WALL	Area/bundle (face ft.)	Lin. Ft.	Pieces	Wt. (lbs)	Layers	Sq. Ft.	Pieces	Wt. (lbs)	Sections	Sq. Ft.	Pieces	Wt. (lbs)
COMBO BUNDLE 16" Unit, 20" Unit, 20" Corner/End Unit, 24" Unit	26	52.5	8 each	3200	4	6.5	2 each	800	-	-	-	-
Corner/Column Unit NEW!	29.1 (Wall) 48.4 (Col)	59	60	2880	4	7.3 (Wall) 12.1 (Col)	15	720	5	5.8 (Wall) 9.7 (Col)	12	576
Coping Unit Coping End Unit	11.6	47.2	16 (Reg) 8 (End)	1872	8 †	1.5	2 (Reg) 1 (End)	234	-	-	-	-

Weights/Piece are approximate.

(Col) = Column
(Reg) = Regular
(End) = End Unit

† = Packaged with mesh between layers

Packaging Specifications

ORTANA	Area/bundle (face ft.)	Per Full Bundle			Per Layer				Per Section			
		Lin. Ft.	Pieces	Wt. (lbs)	Layers	Sq. Ft.	Pieces	Wt. (lbs)	Sections	Sq.Ft.	Pieces	Wt.(lbs)
Standard Unit	19.4	39.4	60	2760	3	6.5	20	920	4	4.9	15	690
Tapered unit	19.4	39.4	60	2400	3	6.5	20	800	4	4.9	15	600
90° Corner Unit	19.4	39.4	24	1128	4	4.9	6	282	6	3.2	4	188
1' Coping Unit	17.7	72	72	2520	6	12	12	420	4	4.4	18	630
2' Coping Unit	11.8	48	24	1680	6	2	4	280	2	5.9	12	840
PROTERRA™ SMOOTH	Area/bundle (face ft.)	Lin. Ft.	Pieces	Wt. (lbs)	Layers	Sq. Ft.	Pieces	Wt. (lbs)	Sections	Sq.Ft.	Pieces	Wt.(lbs)
Standard Unit	18	29.5	9	3150	3	6	3	1050	-	-	-	-
COMBO BUNDLE Standard, Double	6	9.8	3 each	3150	3	2	1 each	1050	-	-	-	-
Triple Unit	6	9.8	3	3150	3	2	1	1050	-	-	-	-
Standard Corner Unit	24.6	40.6	9	3150	3	8.2	3	1050	-	-	-	-
Coping Corner/ End Unit	17.1	28.1	6	2400	3	5.7	2	800	-	-	-	-
Coping-Step Unit	12	19.6	6	2388	3	4	2	796	-	-	-	-
PROTERRA™ SPLIT	Area/bundle (face ft.)	Lin. Ft.	Pieces	Wt. (lbs)	Layers	Sq. Ft.	Pieces	Wt. (lbs)	Sections	Sq.Ft.	Pieces	Wt.(lbs)
Standard Unit	18	29.5	9	3150	3	6	3	1050	-	-	-	-
COMBO BUNDLE Standard, Double	6	9.8	3 each	3150	3	2	1 each	1050	-	-	-	-
Standard Corner Unit	22.4	36.9	9	2772	3	7.4	3	924	-	-	-	-
Coping Corner/ End Unit	15.6	25.7	6	2088	3	5.2	2	696	-	-	-	-
Coping-Step Unit	12	19.6	6	2388	3	4	2	796	-	-	-	-

Weights/Piece are approximate.

(Col) = Column
(Reg) = Regular
(End) = End Unit

CHOOSING A Contractor

You are about to invest in a long-lasting concrete landscape project. Like any construction project, the quality of the final result is highly dependent on the quality of the contractor doing the work.

Recommended Contractor Qualifications:

- Member of ICPI and/or Landscape Ontario
- ICPI Certified Concrete Paver Installer or ICPI Accredited Paver Installer Company
- Project references (recommend installation experience of a minimum of 10,000 square feet)
- 2 year installation warranty
- Verify insurance and applicable licenses
- Adhere to the installation guidelines recommended by ICPI

To find a certified installer visit: www.icpi.org



Capabilities Chart

This chart provides general construction limits based on a typical planter bed behind the wall. Reference the available Estimating Guides (Nueva®, Ortana and Proterra™) for higher retaining walls, where there is any sort of load (slope, fence, traffic) behind the wall, or where any other special conditions exist. Design support is recommended when there is a pedestrian guard required [area behind the wall is accessible and the wall height exceeds 600mm (23.6")] and/or a building permit is required [wall height exceeds 1,000mm (39.4")].

WALL BLOCK TYPE	DESIGN	MAXIMUM WALL HEIGHT UNDER IDEAL CONDITIONS		ADHESIVES REQUIRED	SETBACK ANGLE DEGREES	MINIMUM OUTSIDE RADIUS	
		INCHES	MILLIMETERS			INCHES	MILLIMETERS
Gardenia Linear	Setback	24	600	no	5	n/a	n/a
Laredo	Vertical	19.1	485	yes	0	n/a	n/a
Laredo Smooth	Vertical	19.1	485	yes	0	n/a	n/a
Modan	Vertical	21.7	550	yes	0	n/a	n/a
Modeco One	Vertical	17.5	445	yes	0	30.25	768
Nueva® 75 Wall	Vertical	20.7	525	no	0	n/a	n/a
	Setback	20.7	525	no	3.5	n/a	n/a
Nueva® 150 Wall	Vertical	20.7	525	no	0	n/a	n/a
	Setback	20.7	525	no	3.5	n/a	n/a
Ortana	Vertical	20.7	525	no	0	48	1219
	Setback	26.6	675	no	7	48	1219
Proterra™	Vertical	21.9	555	no	0	n/a	n/a
	Setback	36.4	925	no	8	n/a	n/a

Note 1: Maximum height includes the buried portion of the wall and the coping unit (where applicable)
Note 2: Concrete adhesive is required as there is no form of interlock between units.

Vertical Option

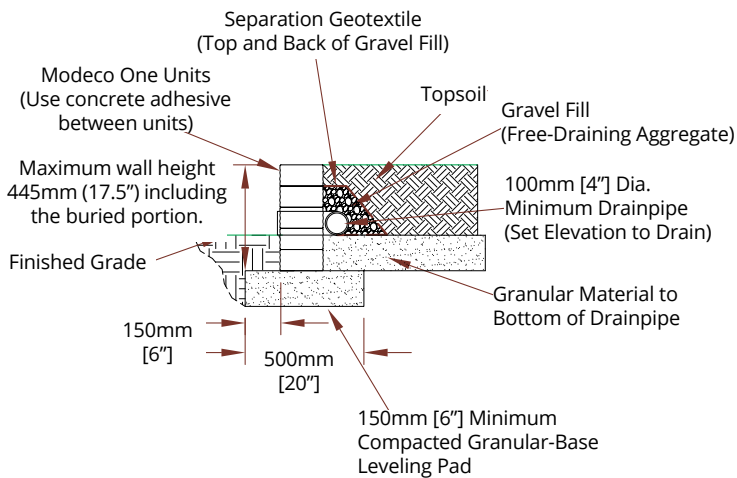

Setback Option

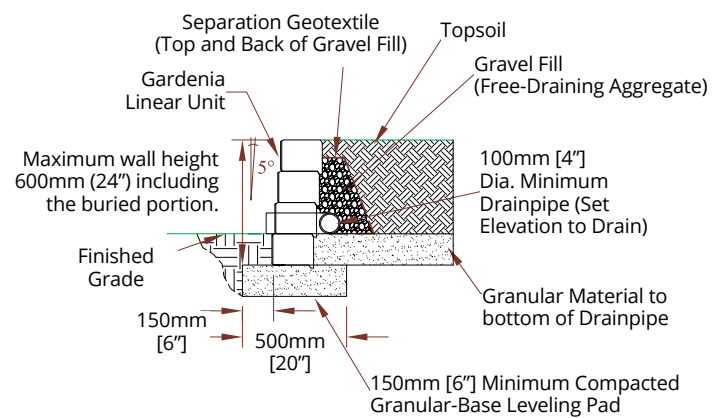

DIY? View our Garden Wall Installation Guide!



Scan to view!
 Visit [OAKSpavers.com/en/resource-search/garden-wall-installation-guidelines](https://oakspavers.com/en/resource-search/garden-wall-installation-guidelines)

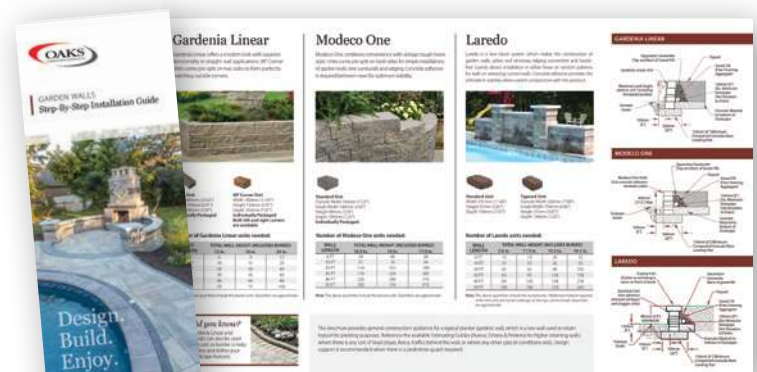

STRENGTH & INTEGRITY

Our guarantee.



Oaks Landscape Products are manufactured to the highest quality standards in a tightly controlled, fully monitored production environment. Oaks Landscape Products warrants the original property owner that the concrete product is free from material defects. Material found to be defective will be replaced without cost. Color matching cannot be guaranteed and replacement labor is not included. This assurance of quality is applicable where concrete products produced by Oaks Landscape Products are installed on the site and is subject to use under normal conditions.



Some Conditions apply.
Scan to view limitations & exclusions.

On the front cover:

Slabs: Nueva® Slab, Champagne with Onyx border

Pool Coping: Nueva® Coping, Champagne

Walls: Proterra™ Smooth, Natural

Distributed by/Authorized Dealer:



OAKSPAVERS.COM

US 1.800.876.OAKS (6257) | **CA** 1.800.709.OAKS (6257)

DETROIT

51744 PONTIAC TRAIL
WIXOM, MI 48393

FARMERSBURG

1256 EAST COUNTY RD. 950 N.
FARMERSBURG, IN 47850

BRAMPTON

225 WANLESS DRIVE
BRAMPTON, ON L7A 1E9

BOISBRIAND

4200, MARCEL-LACASSE
BOISBRIAND, QC J7H 1N3

BROCKVILLE

3007 COUNTY RD. #29, PO BOX 141
BROCKVILLE, ON K6V 5V2

CAMBRIDGE

1038 RIFE ROAD
CAMBRIDGE, ON N1R 5S3

HILLSDALE

2108 FLOS ROAD FOUR EAST
HILLSDALE, ON L0L 1V0

MARKHAM

455 RODICK ROAD
MARKHAM, ON L6G 1B2



Our digital literature is updated throughout the year.
Scan for the latest version.

Product representations shown in this publication are intended to convey the general color, texture and appearance of the product. Variations may occur in the manufacturing and printing process. Always select from current, physical product samples.

USA30K/03/24