



We didn't invent the floating dock.
We just perfected it.

Our Story



Snap Dock's story began in 1982, when our parent company first patented a rotationally molded collapsible container, quickly becoming the standard in the automotive and manufacturing industries. The company later expanded into other rotationally molded products that serve the industrial market. Along the way, we saw an unmet need for a rapidly deployable industrial floating walkway system. In 2018, Snap Dock launched a polyethylene floating walkway for the industrial market. Following the successful launch of this product, we began developing a recreational lineup in 2021 based on our core tenets of durability and ease of use. Each year since, we have sought to consistently expand our offering based on feedback from the market.



Designed With You in Mind

Versatility and Adaptability

Snap Dock's floating dock system is ideal for residential, commercial, and industrial settings, including marinas, restaurants, campgrounds, resorts, and boat rental facilities. Regardless of the project, Snap Dock has you covered.

Superior Performance in Harsh Environments

Snap Dock floats are rotationally molded from linear low-density polyethylene (LLDPE) backed by an 8-year limited warranty. Given that Snap Dock's first customers were industrial operators, you can rest assured that Snap Dock's products are built to withstand the harshest conditions.

Low Maintenance

Snap Dock products require less maintenance than traditional wood dock systems. Due to the unique paver pattern surface that will channel water, and light gray color that hides dirt, the system will maintain its high-end appearance longer.

Modular Design and Easy Installation

Unlike traditional systems and even other plastic floating dock products, Snap Dock's modular design and connection system makes installation quick and straightforward. It can even be done on the water using our in-water installation tool.



The Snap Dock Advantage

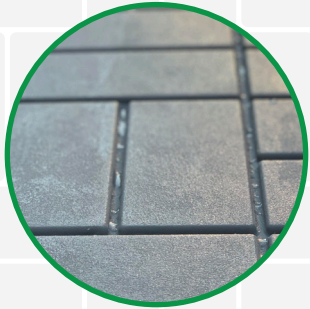

Attractive Non-Slip Surface

All dock sections feature an attractive non-slip surface that channels water and helps conceal dirt.



Unmatched Strength

Snap Dock's coupler system allows our docks to withstand significant wave action in rough water. We guarantee consistent performance in even the most extreme weather conditions.

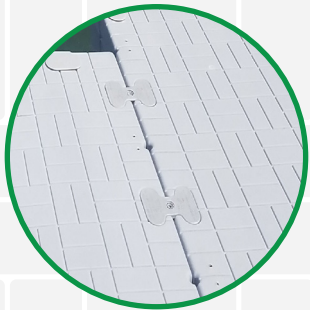

Seamless Color Integration

Snap Dock's coupler system matches seamlessly with your dock system for the perfect aesthetic.



Reinforced Surface Support

Snap Dock's product lineup is engineered with additional material to minimize deflection in the walking surface, ensuring rigidity.



Industrial Grade Durability

All Snap Dock modular components are rotationally molded with industrial grade plastic (LLDPE) ensuring consistent performance in the most extreme weather conditions.



Best-In-Class Customer Service

We are committed to creating a family-like customer experience for distributors, dealers, and end users.



Core of the System

Snap Dock offers a **versatile product line** to meet your waterfront needs, featuring our dock lineup of 40", 40" x 60", 60", and 80" dock sections. These modular sections seamlessly pair with our anchoring brackets, including Standard Duty, Heavy Duty, and Piling Brackets. Thanks to our **patent-pending coupler system**, you can trust Snap Dock for quality, innovation, and simplified solutions in a variety of waterfront environment.

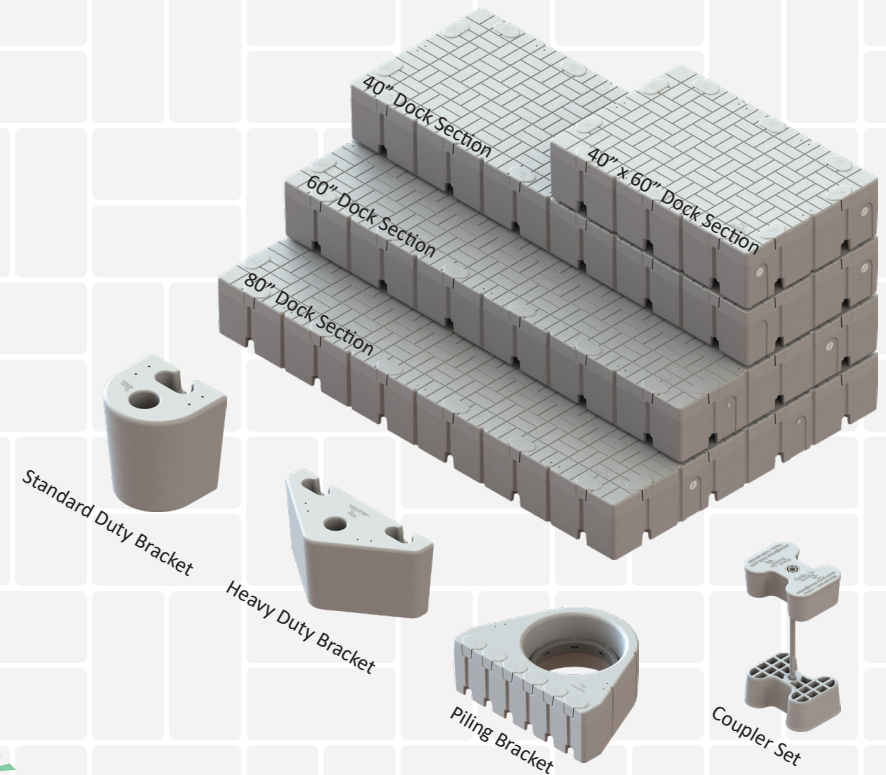

Dock Sections

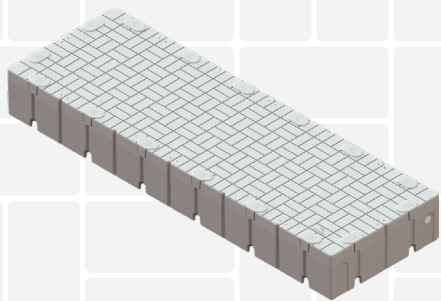

40" Dock Section

Capacity* 2150 lbs / 975 kg
Weight 178 lbs / 81 kg
Dimension 117" x 39" x 15"
SKU SNAP120x40-GR
Color Light Gray

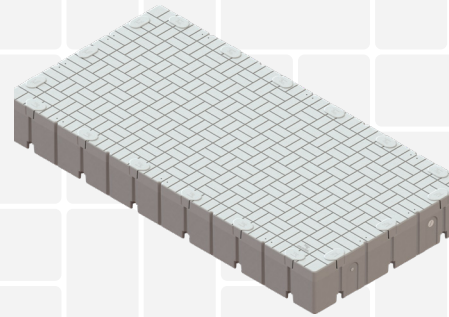

60" Dock Section

Capacity* 3150 lbs / 1440 kg
Weight 270 lbs / 122 kg
Dimension 117" x 59" x 15"
SKU SNAP120x60-GR-2020
Color Light Gray

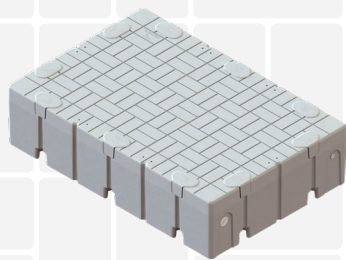

40" x 60" Dock Section

Capacity* 997 lbs / 453 kg
Weight 119 lbs / 54 kg
Dimension 59" x 39" x 15"
SKU SNAP60x40-GR
Color Light Gray

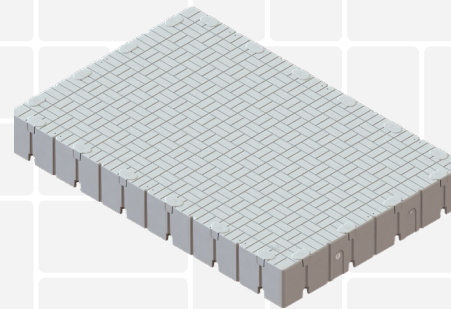

80" Dock Section

Capacity* 4224 lbs / 1916 kg
Weight 330 lbs / 150 kg
Dimension 117" x 79" x 15"
SKU SNAP120x80-GR
Color Light Gray

Capacity at 100% Submersion



Experience the #1 PWC Lift On the Market

Experience a revolutionary approach to floating PWC lifts with Snap Dock's Snap Port lineup. Our unique two-piece design guarantees users the a smooth entry and exit experience. The hinged design allows the hull of the PWC to maintain continuous roller contact. In addition to their soft impact, which minimizes hull stress, the adjustable rollers offer versatility and adaptability for the PWC.

The **Snap Port 80** effortlessly combines a wide walking surface with simplified watercraft access, while the versatile **Snap Port Inline** bundle offers solutions for both residential and commercial applications for multiple watercraft storage. Partnering with Snap Dock isn't merely a product addition—it's a strategic move that will propel your business to the vanguard of the PWC Lift market, guaranteeing adaptable solutions tailored to your customers' needs.

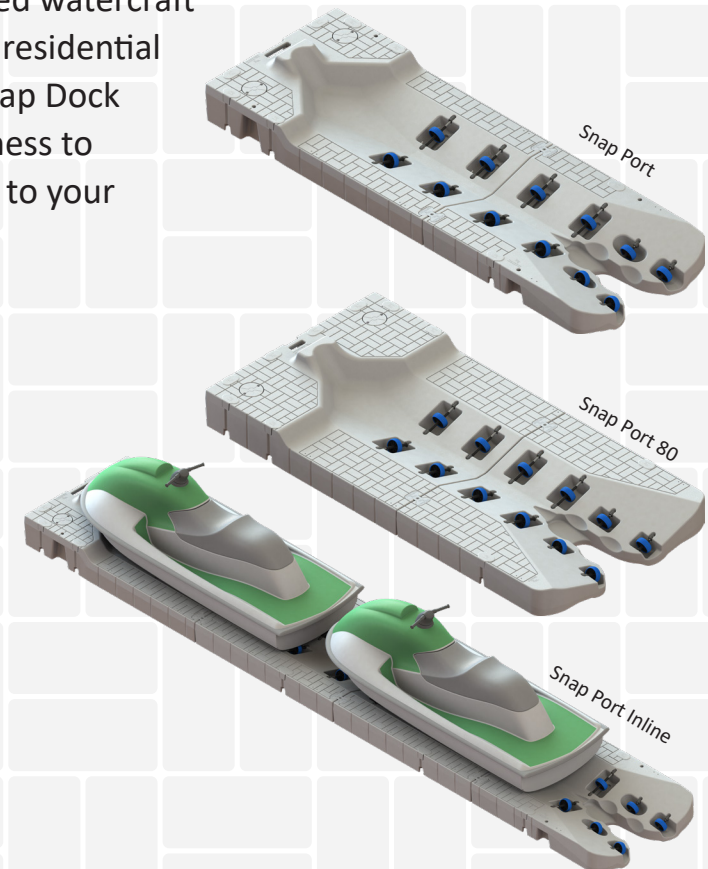

Snap Port Lineup



Snap Port

Capacity* 1750 lbs / 794 kg
Weight 381 lbs / 173 kg
Dimension 168" x 59"
SKU SNAP PORT-GR-ASSY
Color Light Gray



Snap Port 80

Capacity* 1883 lbs / 855 kg
Weight 427 lbs / 194 kg
Dimension 156" x 79"
SKU SNAP PORT80-GR-ASSY
Color Light Gray

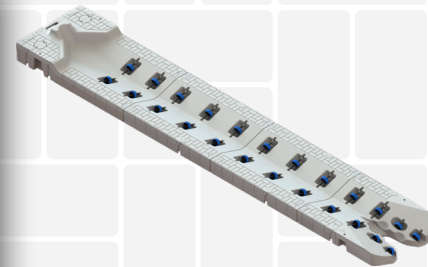

Snap Port Inline

Capacity* 2460 lbs / 1116 kg
Weight 729 lbs / 331 kg
Dimension 326" x 59"
SKU SNAP PORT INLINE-GR-ASSY
Color Light Gray

Endless Possibilities

Explore the limitless potential of our modular floating dock system, ideal for various activities like sunbathing, swimming, kayaking, or jetskiing. Our system is adaptable, durable, and perfect for any waterfront lifestyle, whether it's for family fun, social gatherings, or personal relaxation. For business owners, the modular design means docks can expand as your business grows. This offers a scalable solution that evolves with your commercial needs, enhancing customer experience and boosting your waterfront offerings.

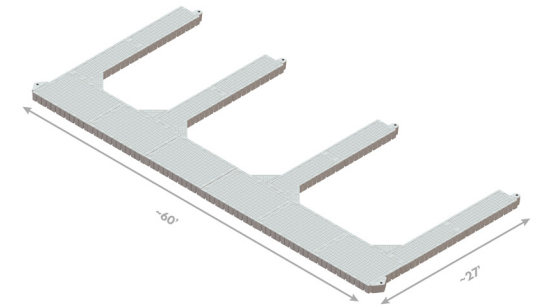

Commercial Multi-Boat Slip Configuration

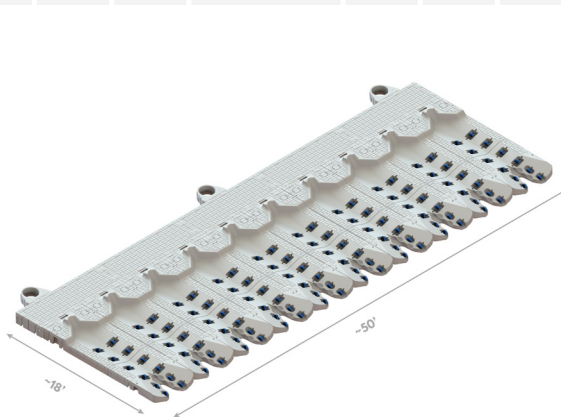

Commercial Multi-PWC Slip Configuration

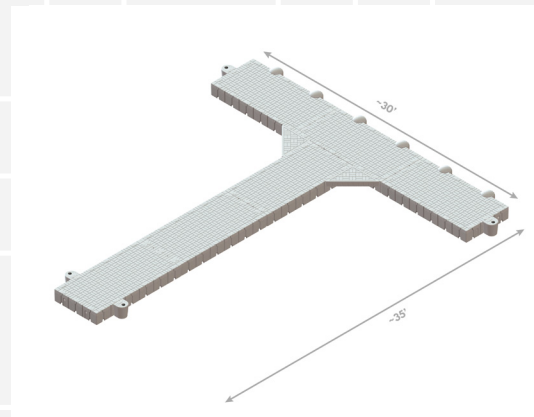

Recreational Configuration

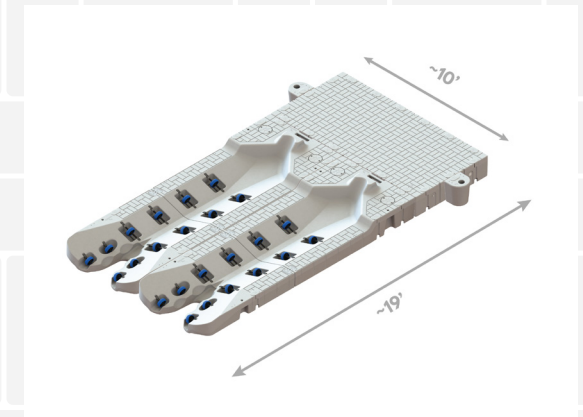

Recreational Multi-PWC Configuration

Coupler System

Snap Dock's patent-pending coupler system uses engineered rubber composite, making each coupler strong, flexible, and lightweight. This unique combination ensures our docks will perform well in the most extreme weather conditions. The coupler system enhances the overall aesthetics of any dock by blending in with the dock sections and components.



Color-Matched Coupler System

Coupler Set



Male Half Coupler



Female Half Coupler



Anchoring Solutions

Our Snap Dock anchoring solutions offer a range of options for various waterfront needs. Our lineup includes pipe and piling anchoring that seamlessly integrates with our dock systems. We also provide metal anchoring options in galvanized and stainless steel for enhanced durability in marine environments. Each product is designed for easy installation and reliable performance in a range of settings.

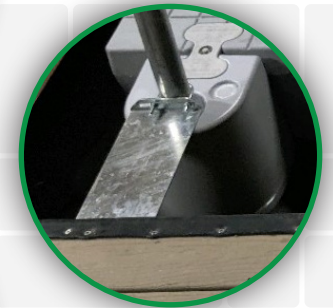

Gallery

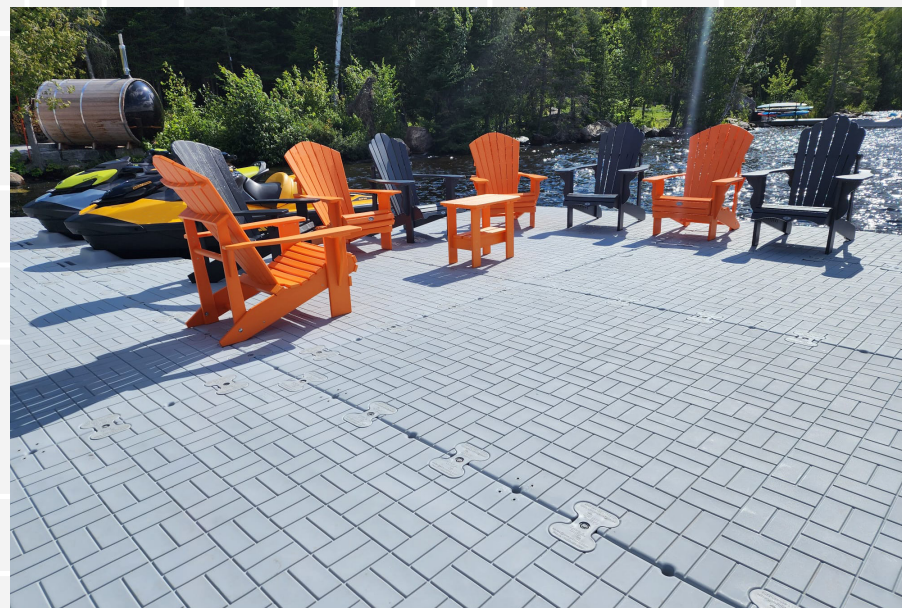

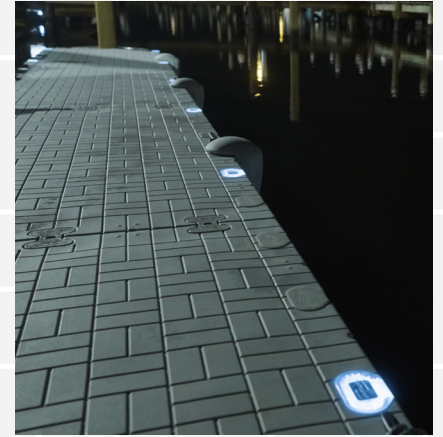

**We didn't invent the floating dock.
We just perfected it.**





1-800-483-5205
sales@snapdock.com
snapdock.com

11405 N. Pennsylvania Street,
Ste. 106,
Carmel, IN 46032
United States

